

T E C H N I C A L G U I D E

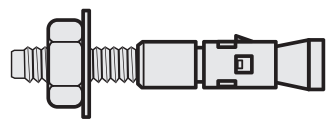

Wedge Anchors

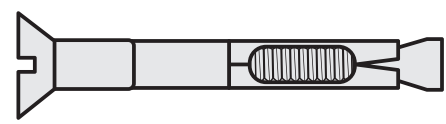

Flat Head Sleeve Anchors

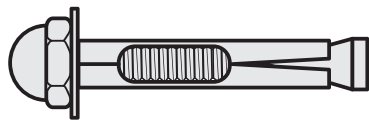

Acorn Nut Sleeve Anchors

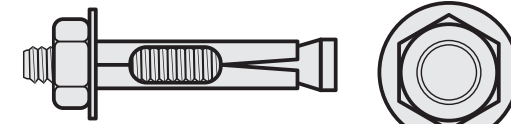

Hex Nut Sleeve Anchors

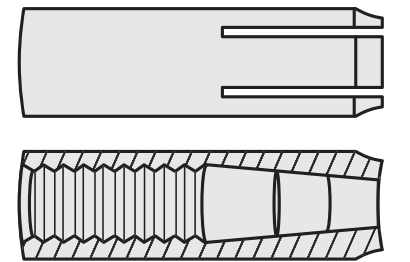

Drop-In Anchors

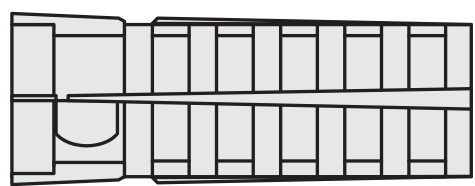

Lag Screw Shields (Long/Short)

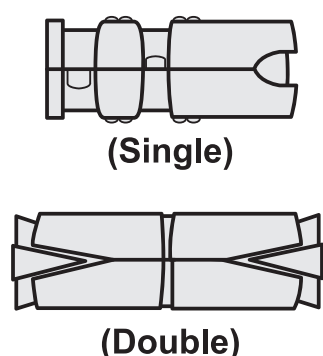

Expansion Anchors

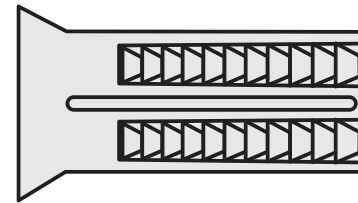

Lead Wood Screw Anchors

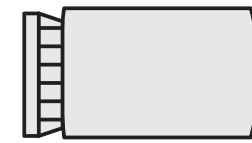

Machine Screw Anchors

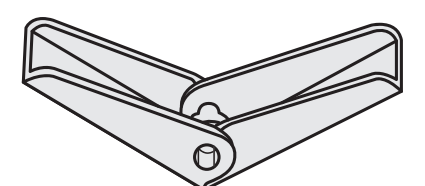

Toggle Wings

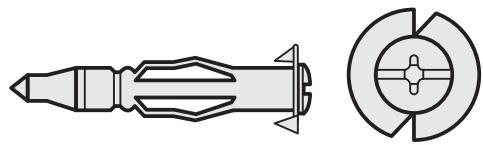

Hollow Wall Drive Anchors

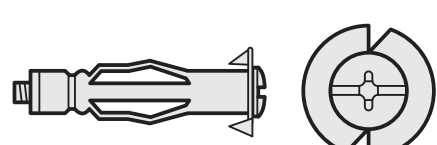

Hollow Wall Anchors



Hammer Drive
Mushroom Head Anchors



Hammer Drive
Flat Head Anchors

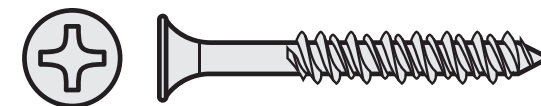

Concrete Screws

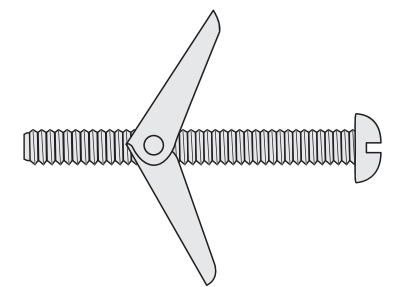

Toggle Bolts

Anchor Selection Guide

HEAVIER DUTY	TYPE OF ANCHOR	FASTENING BASE MATERIAL						• Suitable ▲ May Be Suitable, Depending on Application			
		SOLID CONCRETE	HOLLOW CONCRETE BLOCK	SOLID BRICK	HOLLOW BRICK	STONE	TILE	DRYWALL, PLASTER, PLYWOOD	USED WITH OTHER FASTENERS	MATERIAL / FINISH	TOOLS REQUIRED
	Wedge Anchor	•		▲		▲			none	steel zinc	drill, hammer, wrench
	Sleeve Anchor	•	•	•	•	▲			none	steel zinc	drill, hammer, wrench
	Drop-In Anchor	•							threaded rod, bolt	steel zinc	drill, hammer, setting tool
	Expansion Shield	•	▲	•	▲	•			machine screw or bolt	zinc alloy	drill, wrench
	Concrete Screw	•	▲	•	▲	•			none	steel blue polymer	drill, phillips bit or socket wrench
	Lag Shield	•	▲	•	▲	•	▲		lag screw	zinc alloy	drill, hammer, wrench
	Wood Screw Anchor	•	▲	•	▲	•		▲	wood screw, lag screw, or tapping screw	lead alloy	drill, hammer, screwdriver or bit
	Toggle Wing		•		•		•	•	machine screw	steel zinc	drill, screwdriver or bit
	Toggle Bolt		•		•		•	•	none	steel zinc	drill, screwdriver or bit
	Hollow Wall Anchor		•		•		▲	•	none	steel zinc	drill, rubber mallet, screwdriver or bit
	Machine Screw Anchor	•		•		•			machine screw	zinc alloy, lead alloy	drill, hammer, setting tool, screw driver or wrench
	Hammer Drive Anchor	•	▲	•	▲	•			none	zinc alloy	drill, hammer