

Proffered®



CONSTRUCTION
FASTENER SOURCE

Drywall/Deck/Concrete/Self-Drill Screws - Rivets - Abrasives - Hand Tools

A Brighton-Best International Brand

Proferred®

9-13

DRYWALL SCREWS

- 9 COARSE THREAD BUGLE HEAD PHILLIPS DRIVE DRYWALL SCREWS
- 10 FINE THREAD BUGLE HEAD PHILLIPS DRIVE DRYWALL SCREWS
- 10 MODIFIED TRUSS HEAD PHILLIPS DRIVE DRYWALL SCREWS
- 11 HIGH-LOW THREAD BUGLE HEAD PHILLIPS DRIVE DRYWALL SCREWS
- 11 TRIM HEAD SQUARE DRIVE DRYWALL SCREWS
- 11 LAMINATING BUGLE HEAD PHILLIPS DRIVE DRYWALL SCREWS
- 12 COLLATED DRYWALL SCREWS
- 13 PAN FRAMING HEAD PHILLIPS DRIVE DRYWALL SCREWS

13-17

SELF-DRILL SCREWS

- 13 PAN FRAMING HEAD PHILLIPS DRIVE SELF-DRILL SCREWS
- 13 BUGLE HEAD PHILLIPS DRIVE SELF-DRILL SCREWS
- 14 MODIFIED TRUSS HEAD PHILLIPS DRIVE SELF-DRILL SCREWS
- 14 WAFER HEAD PHILLIPS DRIVE SELF-DRILL SCREWS
- 15 REAMER HEAD PHILLIPS DRIVE SELF-DRILL SCREWS
- 15 WAFER HEAD W/ WINGS PHILLIPS DRIVE SELF-DRILL SCREWS
- 15 TRIM HEAD SQUARE DRIVE SELF-DRILL SCREWS
- 16 HEX WASHER HEAD (HWH) NON-SLOTTED SELF-DRILL SCREWS
- 16 PAN HEAD PHILLIPS DRIVE SELF-DRILL SCREWS
- 17 HEX WASHER HEAD (HWH) W/ BONDED WASHER NON-SLOTTED SELF-DRILL SCREWS

18

CEMENT BOARD SCREWS

- 18 FLAT HEAD COMBO DRIVE CEMENT BOARD SCREWS
- 18 FLAT HEAD POSI DRIVE CEMENT BOARD SCREWS

18-20

DRIVE BITS

- 18 DRIVE BITS
- 20 NUT SETTERS

21-26

DECK SCREWS

- 21 MAX DRIVE 6 LOBE FLAT HEAD DECK SCREWS
- 23 COMBO DRIVE DECK SCREWS
- 25 SQUARE DRIVE COMPOSITE DECK SCREWS
- 25 BUGLE HEAD SQUARE DRIVE TYPE 17 18-8 STAINLESS STEEL DECK SCREWS
- 25 BUGLE HEAD W/ NIBS SQUARE DRIVE TYPE 17 18-8 STAINLESS STEEL DECK SCREWS
- 26 BUGLE HEAD PHILLIPS DRIVE TYPE 17 18-8 STAINLESS STEEL DECK SCREWS
- 26 BUGLE HEAD PHILLIPS DRIVE TYPE 17 316 STAINLESS STEEL DECK SCREWS

27-38

RIVETS

- 27 LARGE DOME HEAD BLIND RIVETS
- 28 COUNTERSUNK BLIND RIVETS
- 29 DOME HEAD BLIND RIVETS
- 34 DOME HEAD CLOSED-END BLIND RIVETS
- 34 COUNTERSUNK CLOSED-END BLIND RIVETS
- 36 DOME HEAD MULTI-GRIP TYPE BLIND RIVETS
- 38 BACKUP RIVET WASHERS

39-42

DRILL BITS

- 39 SDS-PLUS CARBIDE BITS
- 41 SDS-MAX CARBIDE BITS
- 42 SDS-PLUS CARBIDE BITS & STOP
- 42 SDS-HEX CARBIDE BITS

43-45

CUTOFF WHEELS

- 43 CUTOFF WHEELS
- 44 GRINDING WHEELS
- 44 FLAP DISCS
- 45 HAND PADS

46-47

HAND TOOLS

- 46 HAMMERS
- 46 SNIPS
- 46 WRENCHES
- 46 PLIERS
- 46 SCREWDRIVERS
- 47 STAPLE GUN
- 47 TAPE MEASURE
- 47 UTILITY KNIFE
- 47 LED FLASHLIGHTS
- 47 PACKAGING TAPES / DUCT TAPES / ELECTRICAL TAPES / THREAD SEALING TAPES
- 47 CAUTION/ DANGER TAPES
- 47 WASTE BAGS
- 47 CARPENTER PENCIL
- 47 HAND & TOOL WIPES
- 47 SHOP TOWELS

48-52

PERSONAL PROTECTIVE EQUIPMENT

48	NITRILE GLOVES
48	INDUSTRIAL GLOVES
50	SAFETY GLASSES
51	SAFETY GOGGLES
51	SAFETY VESTS
52	KNEE PADS
52	LED PORTABLE WORKLIGHT
52	BOUFFANT CAP
52	SHOE COVERS
52	RAIN COATS
52	EAR PLUGS
52	EAR MUFFS
52	N95 MASKS



55-63

ANCHORS

55	TAPKING SD FLAT HEAD PHILLIPS DRIVE CONCRETE SCREWS
55	TAPKING SD INDENT HEX WASHER HEAD (HWH) CONCRETE SCREWS
56	TAPKING SD TRIM HEAD PHILLIPS DRIVE CONCRETE SCREWS
56	TAPKING HD CONCRETE SCREWS
57	ULTRAWEDGE+ CONCRETE WEDGE ANCHORS
58	ULTRAWEDGE CONCRETE WEDGE ANCHORS
60	SLEEVE ANCHORS
61	FLAT HEAD SLEEVE ANCHORS
61	ROUND HEAD SLEEVE ANCHORS
61	ACORN HEAD SLEEVE ANCHORS
62	ROD HANGER SLEEVE ANCHORS
62	HEX HEAD SLEEVE ANCHORS
62	DROP-IN ANCHORS
63	EZ ANCHORS
63	TOGGLER ANCHORS



67-70

IRONCLAD®

- 69 COMMAND KNIT FOAM NITRILE CUT LEVEL A1
- 69 COMMAND KNIT PU CUT LEVEL A1
- 69 COMMAND KNIT PU CUT LEVEL A2
- 69 COMMAND KNIT FOAM NITRILE CUT A1
- 69 COMMAND KNIT FOAM NITRILE CUT LEVEL A3
- 69 COMMAND KNIT FOAM NITRILE CUT LEVEL A4
- 69 COMMAND KNIT FOAM NITRILE CUT LEVEL A6
- 69 COMMAND KNIT MICROFOAM NITRILE
- 69 FOAM STANDING / KNEELING PAD
- 70 CRINKLE LATEX CUT LEVEL A1
- 70 HARD HATS / BUMP CAPS



**BRIGHTON-BEST
INTERNATIONAL**

71

ADDITIONAL CONSTRUCTION PRODUCTS

Proffered®

Quality Products You Can Trust!

Along with the largest and most diverse fastener inventory in the world, Brighton-Best International stocks the Award-Winning **Proffered**® brand, a complete line of construction fasteners, tools, industrial products, consumables and safety gloves.

Proffered Drywall, Self-Drill and Cement Board Screws, sourced from a single Certified Taiwan Factory, are the GO-TO screws for construction screws.

- **Proffered Drywallersz™** perform 3X faster than the average drill time earning the 2018 Pro Tool Innovation Award for screw design.
- **Proffered Drillersz™**, or Self-Drill Screws, are ICC Approved - An approval required by many government & municipality jobs throughout the U.S.

All **Proffered** screws are manufactured utilizing the highest quality cold headed wire available, and thread rolling dies are changed out frequently, assuring every screw manufactured maintains extremely sharp points and threads, providing our customers with one of the highest quality - most consistent - fastest installing screws in today's marketplace!

Offering full lot traceability for stringent quality control, and color coded cartons for ease of product identification, **Proffered** screws are readily available in bulk, 1lb & 5lb package configurations.

The award-winning **Proffered** line of products also includes Hand Tools, Cutting Tools, Abrasives & Rivets. Our hand tools carry a Lifetime Guarantee, have won the PTIA award 3 years in a row, and now includes safety supplies and consumables such as gloves, cable ties, tape & glue.

In addition to **Proffered**, BBI now offers construction professionals Ironclad® Performance Wear gloves. Born on a construction jobsite in 1998, Ironclad invented the high performance, task-specific work glove in direct response to the needs of construction professionals.

Prior to Ironclad, work gloves were non industry specific, offered minimal hand or impact protection, and got in the way of getting the job done. Ironclad filled the void by creating a new class of gloves that are: Industry Specific, Breathable, Washable, offering High Dexterity and overall excellent hand protection. These features have made Ironclad® gloves the go-to choice for construction professionals nationwide.

With over 70,000 SKUs, BBI offers competitive pricing, 20 U.S. distribution centers, 30 global, state of the art technology with 24/7 stock status and order entry via the web. BBI is committed to bringing quality, innovation, and safety to every job site.

Contact your local BBI representative for free **Proffered** or Ironclad samples.

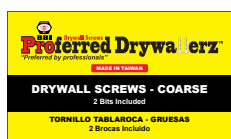

Coarse Thread - Bulk



Fine Thread - Bulk



Self-Drill - Bulk



Coarse Thread - Package



Fine Thread - Package



Self-Drill - Package

You can find more information on Proffered Screws, including technical data sheets, online at www.profferedscrews.com.

Proffered also offers high-quality product displays, with red framing and black steel peg-boards for hand tools and packaged Drywall & Self-Drill Screws.

Displays are versatile and can be used to display both hand tools and packages.

All divisions of Proffered®, U.S. Anchor and Ironclad® Gloves are trademarked, owned and operated by Brighton-Best International.



DRYWALL SCREWS, SELF-DRILL SCREWS, CEMENT BOARD SCREWS, DECK SCREWS, AND PLATING TYPES



Bugle Head Phillips
Coarse Thread Screw,
Black Phosphate



Bugle Head Phillips
Coarse Thread Screw,
Zinc Yellow



Bugle Head Phillips
Fine Thread, Sharp Point
Screw, Black Phosphate



Modified Truss Head
Phillips, Sharp Point
Screw, Zinc Plated CR+3



Bugle Head Phillips
High-Low Thread Screw,
Black Phosphate



Trim Head Square Drive
Screw, Sharp Point,
Black Phosphate



Bugle Head Phillips
Laminating Screw,
Black Phosphate



Pan Framing Phillips,
Sharp Point Screw,
Black Phosphate



Pan Framing Phillips,
Self-Drill Screw,
Zinc Plated CR+3



Bugle Head Phillips
Self-Drill Screw,
Black Phosphate



Bugle Head Phillips
Self-Drill Screw,
Zinc Plated CR+3



Modified Truss Head
Self-Drill Screw,
Zinc Plated CR+3



Wafer Head Phillips
Self-Drill Screw,
Zinc Plated CR+3



Wafer Head Phillips
Self-Drill w/Wings,
Zinc Plated CR+3



Trim Head Square Drive
Self-Drill Screw,
Zinc Plated CR+3



Non-Slotted Indent Hex
Washer Head
Self-Drill Screw,
Zinc Plated CR+3



Pan Phillips
Self-Drill Screw,
Zinc Plated CR+3



Non-Slotted Hex Washer
Head w/Bonded
EPDM Washer
Self-Drill Screw,
Zinc Plated CR+3



Phillips Combo Drive
Cement/Fiber Board
Screw, Sharp Point,
Green Coating
1500 Hr. Salt Spray



Posi-Drive
Cement/Fiber Board
Screw, Self-Drill,
Green Coating
1500 Hr. Salt Spray



Flat Head 6 Lobe Drive
Type-17 Point Deck
Screw, Color-Bronze
1500 Hr. Salt Spray



Flat Head Phillips Square
Drive Deck Screw,
Color-Tan
1500 Hr. Salt Spray



Flat Head Phillips Square
Drive Deck Screw,
Color-Red
1500 Hr. Salt Spray



Flat Head Phillips Square
Drive Deck Screw,
Color-Green
1500 Hr. Salt Spray



Button Head Square
Drive Composite Screw,
Color-Gray, Tan, Red
1500 Hr. Salt Spray



Flat Head Square Drive
Type-17 Point
Deck Screw,
18-8 Stainless



Flat Head Square Drive
Type-17 Point w/Nibs
Deck Screw,
18-8 Stainless



Flat Head Phillips Drive
Type-17 Point
Deck Screw,
18-8 Stainless



Flat Head Square Drive
Type-17 Point
Deck Screw,
316 Stainless



Flat Phillips &
Hex Washer Head
Concrete Screw





Proferred[®]

**YOUR COMMERCIAL &
RESIDENTIAL FASTENER SOURCE**

DRYWALL TO WOOD - For Attaching Drywall / Gypsum Board To Wood

COARSE DRYWALL SCREWS



Drive Bit: PHR-2

- Bugle Head
- #2 Reduced Phillips Drive
- Black Phosphate
- COO: Taiwan
- Carton Color: Yellow

Part No.	Item Description	Size	Bulk Qty.
064010	Bugle Phil, Coarse Thread, Black Phos	#6-9x3/4"	15000
064020	Bugle Phil, Coarse Thread, Black Phos	#6-9x1"	10000
064030	Bugle Phil, Coarse Thread, Black Phos	#6-9x1 1/8"	10000
064040	Bugle Phil, Coarse Thread, Black Phos	#6-9x1 1/4"	8000
064050	Bugle Phil, Coarse Thread, Black Phos	#6-9x1 1/2"	6000
064060	Bugle Phil, Coarse Thread, Black Phos	#6-9x1 5/8"	5000
064500	Bugle Phil, Coarse Thread, Black Phos	#6-9x1 3/4"	4000
064070	Bugle Phil, Coarse Thread, Black Phos	#6-9x2"	3500
064080	Bugle Phil, Coarse Thread, Black Phos	#6-9x2 1/4"	3000
064530	Bugle Phil, Coarse Thread, Black Phos	#7-9x1 1/2"	6000
064501	Bugle Phil, Coarse Thread, Black Phos	#7-9x2"	3500
064531	Bugle Phil, Coarse Thread, Black Phos	#7-9x2 1/4"	3000
064190	Bugle Phil, Coarse Thread, Black Phos	#7-9x2 1/2"	2500
064090	Bugle Phil, Coarse Thread, Black Phos	#8-8x1 5/8"	4000
064508	Bugle Phil, Coarse Thread, Black Phos	#8-8x2"	2000
064100	Bugle Phil, Coarse Thread, Black Phos	#8-8x2 1/2"	2500
064110	Bugle Phil, Coarse Thread, Black Phos	#8-8x3"	2000
064120	Bugle Phil, Coarse Thread, Black Phos	#10-8x3 1/2"	1000
064516	Bugle Phil, Coarse Thread, Black Phos	#10-8x3 3/4"	1000
064130	Bugle Phil, Coarse Thread, Black Phos	#10-8x4"	1000
064517	Bugle Phil, Coarse Thread, Black Phos	#10-8x4 1/2"	750
064518	Bugle Phil, Coarse Thread, Black Phos	#10-8x5"	500
064519	Bugle Phil, Coarse Thread, Black Phos	#10-8x6"	500

We do not recommend using a standard PH-2 drive bit with Proffered drywall screws. PH-2 bits have a slightly wider wing span and will not fully seat into the screw recess, causing unnecessary wobble and possible cam-outs.

DRYWALL TO WOOD - For Attaching Wood To Wood

COARSE DRYWALL SCREWS



Drive Bit: PHR-2

- Bugle Head
- #2 Reduced Phillips Drive
- Zinc Yellow
- COO: Taiwan
- Carton Color: Yellow

Part No.	Item Description	Size	Bulk Qty.
070010	Bugle Phil, Coarse Thread, Zinc Yellow	#6-9x1"	10000
070020	Bugle Phil, Coarse Thread, Zinc Yellow	#6-9x1 1/8"	10000
070030	Bugle Phil, Coarse Thread, Zinc Yellow	#6-9x1 1/4"	8000
070040	Bugle Phil, Coarse Thread, Zinc Yellow	#6-9x1 5/8"	5000
070050	Bugle Phil, Coarse Thread, Zinc Yellow	#6-9x2"	3500
070060	Bugle Phil, Coarse Thread, Zinc Yellow	#6-9x2 1/4"	3000
070070	Bugle Phil, Coarse Thread, Zinc Yellow	#8-8x2 1/2"	2500
070080	Bugle Phil, Coarse Thread, Zinc Yellow	#8-8x3"	2000
070110	Bugle Phil, Coarse Thread, Zinc Yellow	#10-8x3 1/2"	1000
070120	Bugle Phil, Coarse Thread, Zinc Yellow	#10-8x4"	1000
070130	Bugle Phil, Coarse Thread, Zinc Yellow	#10-8x4 1/2"	750
070140	Bugle Phil, Coarse Thread, Zinc Yellow	#10-8x5"	750
070150	Bugle Phil, Coarse Thread, Zinc Yellow	#10-8x6"	500

We do not recommend using a standard PH-2 drive bit with Proffered drywall screws. PH-2 bits have a slightly wider wing span and will not fully seat into the screw recess, causing unnecessary wobble and possible cam-outs.

DRYWALL TO METAL - For Attaching Drywall / Gypsum Board To 20-25 Light Gauge Steel Studs

FINE DRYWALL SCREWS



Drive Bit: PHR-2

- Bugle Head
- #2 Reduced Phillips Drive
- Black Phosphate
- COO: Taiwan
- Carton Color: White

Part No.	Item Description	Size	Bulk Qty.
064520	Bugle Phil, Fine Thread, Sharp Point, Black Phos	#6-18x3/4"	15000
064021	Bugle Phil, Fine Thread, Sharp Point, Black Phos	#6-18x1"	10000
064031	Bugle Phil, Fine Thread, Sharp Point, Black Phos	#6-18x1 1/8"	10000
064041	Bugle Phil, Fine Thread, Sharp Point, Black Phos	#6-18x1 1/4"	8000
064051	Bugle Phil, Fine Thread, Sharp Point, Black Phos	#6-18x1 1/2"	6000
064061	Bugle Phil, Fine Thread, Sharp Point, Black Phos	#6-18x1 5/8"	5000
064521	Bugle Phil, Fine Thread, Sharp Point, Black Phos	#6-18x1 3/4"	4000
064071	Bugle Phil, Fine Thread, Sharp Point, Black Phos	#6-18x2"	3500
064081	Bugle Phil, Fine Thread, Sharp Point, Black Phos	#6-18x2 1/4"	3000
064522	Bugle Phil, Fine Thread, Sharp Point, Black Phos	#6-18x2 1/2"	2500
064523	Bugle Phil, Fine Thread, Sharp Point, Black Phos	#7-16x1 1/4"	8000
064524	Bugle Phil, Fine Thread, Sharp Point, Black Phos	#7-16x1 1/2"	6000
064525	Bugle Phil, Fine Thread, Sharp Point, Black Phos	#7-16x1 3/4"	4000
064526	Bugle Phil, Fine Thread, Sharp Point, Black Phos	#7-16x2"	3500
064527	Bugle Phil, Fine Thread, Sharp Point, Black Phos	#7-16x2 1/4"	3000
064528	Bugle Phil, Fine Thread, Sharp Point, Black Phos	#8-15x2"	3500
064101	Bugle Phil, Fine Thread, Sharp Point, Black Phos	#8-15x2 1/2"	2500
064111	Bugle Phil, Fine Thread, Sharp Point, Black Phos	#8-15x3"	2000
064121	Bugle Phil, Fine Thread, Sharp Point, Black Phos	#10-12x3 1/2"	1000
064529	Bugle Phil, Fine Thread, Sharp Point, Black Phos	#10-12x3 3/4"	1000
064131	Bugle Phil, Fine Thread, Sharp Point, Black Phos	#10-12x4"	1000
064141	Bugle Phil, Fine Thread, Sharp Point, Black Phos	#10-12x4 1/2"	750
064151	Bugle Phil, Fine Thread, Sharp Point, Black Phos	#10-12x5"	500
064181	Bugle Phil, Fine Thread, Sharp Point, Black Phos	#10-12x6"	500

We do not recommend using a standard PH-2 drive bit with Proferred drywall screws. PH-2 bits have a slightly wider wing span and will not fully seat into the screw recess, causing unnecessary wobble and possible cam-outs.

METAL LATH TO WOOD - For Attaching Metal Lath To 20-25 Light Gauge Steel Studs Prior To Stucco

MODIFIED TRUSS, SHARP POINT



Drive Bit: PH-2

- Modified Truss Head
- #2 Phillips Drive
- Zinc Plated CR+3
- COO: Taiwan
- Carton Color: Yellow

Part No.	Item Description	Size	Bulk Qty.
W75012	Modified Truss, Phil Sharp point, Zinc Plated CR+3	#8x1/2"	10,000
W75034	Modified Truss, Phil Sharp point, Zinc Plated CR+3	#8x3/4"	8,000
W75114	Modified Truss, Phil Sharp point, Zinc Plated CR+3	#8x1 1/4"	5,000
W75158	Modified Truss, Phil Sharp point, Zinc Plated CR+3	#8x1 5/8"	4,000
W75200	Modified Truss, Phil Sharp point, Zinc Plated CR+3	#8x2"	2,500
W75212	Modified Truss, Phil Sharp point, Zinc Plated CR+3	#8x2 1/2"	2,000
W75300	Modified Truss, Phil Sharp point, Zinc Plated CR+3	#8x3"	1,500

DRYWALL TO LIGHT GAUGE METAL - For Attaching Drywall To 20-25 Light Gauge Steel Studs, And Applications Requiring Greater Strip-Out Resistance

HIGH-LOW DRYWALL SCREWS



Drive Bit: PHR-2

- Bugle Head
- #2 Reduced Phillips Drive
- Black Phosphate
- COO: Taiwan
- Carton Color: Yellow

Part No.	Item Description	Size	Bulk Qty.
064204	Phil Bugle, High-Low Thread, Black Phos	#6x1 1/8"	10000
064206	Phil Bugle, High-Low Thread, Black Phos	#6x1 1/4"	8000
064208	Phil Bugle, High-Low Thread, Black Phos	#6x1 5/8"	5000
064210	Phil Bugle, High-Low Thread, Black Phos	#6x2"	5000
064212	Phil Bugle, High-Low Thread, Black Phos	#6x2 1/4"	3000
064230	Phil Bugle, High-Low Thread, Black Phos	#7x2 1/2"	2500
064240	Phil Bugle, High-Low Thread, Black Phos	#8x3"	2000

We do not recommend using a standard PH-2 drive bit with Proferred drywall screws. PH-2 bits have a slightly wider wing span and will not fully seat into the screw recess, causing unnecessary wobble and possible cam-outs.

WOOD TRIM & BASE BOARD - For Attaching Wood Trim And Base Board Over Drywall To 20-25 Light Gauge Steel Studs

TRIM HEAD

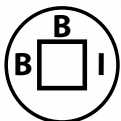

**Drive Bit:
#2 Square Drive**

- Trim Head Drive
- #2 Square Drive
- Black Phosphate
- COO: Taiwan
- Carton Color: Yellow

Part No.	Item Description	Size	Bulk Qty.
064400	Trim Head Square Drive, Sharp Point, Black Phos	#6x1 5/8"	5000
064410	Trim Head Square Drive, Sharp Point, Black Phos	#6x2 1/4"	3000
064430	Trim Head Square Drive, Sharp Point, Black Phos	#8x3"	2000

DRYWALL TO DRYWALL - For Attaching Drywall Over Drywall, Or Wood To Wood

LAMINATING



Drive Bit: PHR-2

- Bugle Head
- #2 Reduced Phillips Drive
- Black Phosphate
- COO: Taiwan
- Carton Color: Yellow

Part No.	Item Description	Size	Bulk Qty.
064333	Bugle Phil, Laminating, Coarse Thread, Black Phos	#10x1 1/2"	5000

We do not recommend using a standard PH-2 drive bit with Proferred drywall screws. PH-2 bits have a slightly wider wing span and will not fully seat into the screw recess, causing unnecessary wobble and possible cam-outs.

DRYWALL TO WOOD - For Attaching Drywall / Gypsum Board To Wood

COLLATED - COARSE DRYWALL SCREWS



Drive Bit: PHR-2

Part No.	Item Description	Size	Bulk Qty.
064940	Collated Bugle Phil, Coarse Thread, Black Phos	#6-9x1 1/4"	10000
064960	Collated Bugle Phil, Coarse Thread, Black Phos	#6-9x1 5/8"	10000

We do not recommend using a standard PH-2 drive bit with Proferred drywall screws. PH-2 bits have a slightly wider wing span and will not fully seat into the screw recess, causing unnecessary wobble and possible cam-outs.

DRYWALL TO METAL - For Attaching Drywall / Gypsum Board To 20-25 Light Gauge Steel Studs

COLLATED - FINE DRYWALL SCREWS



Drive Bit: PHR-2

Part No.	Item Description	Size	Bulk Qty.
064941	Collated Bugle Phil, Fine Thread, Sharp Point, Black Phos	#6-18x1 1/4"	10000
064961	Collated Bugle Phil, Fine Thread, Sharp Point, Black Phos	#6-18x1 5/8"	10000

We do not recommend using a standard PH-2 drive bit with Proferred drywall screws. PH-2 bits have a slightly wider wing span and will not fully seat into the screw recess, causing unnecessary wobble and possible cam-outs.

DRYWALL TO METAL - For Attaching Drywall To 14-20 Gauge Steel Studs

COLLATED - SELF-DRILL BUGLE HEAD



Drive Bit: PH-2

Part No.	Item Description	Size	Bulk Qty.
636905	Collated Self-Drill, Bugle Phil, #2 Point, Zinc Plated CR+3	#6-20x1 1/4"	10000
636956	Collated Self-Drill, Bugle Phil, #2 Point, Zinc Plated CR+3	#6-20x1 5/8"	10000

METAL TO METAL - For Attaching 20-25 Light Gauge Steel Track To 20-25 Light Gauge Steel Studs

PAN PHIL FRAMING

Part No.	Item Description	Size	Bulk Qty.
064258	Pan Phil Framing, Sharp Point, Black Phos	#7x7/16"	10000



We do not recommend using a standard PH-2 drive bit with Proffered drywall screws. PH-2 bits have a slightly wider wing span and will not fully seat into the screw recess, causing unnecessary wobble and possible cam-outs.



Drive Bit: PHR-2

- Pan Framing Head
- Black Phosphate
- #2 Reduced Phillips Drive
- COO: Taiwan
- Carton Color: White

METAL TO METAL - For Attaching 16-20 Gauge Steel Track To 16-20 Gauge Steel Studs

SELF-DRILL PAN FRAMING

Part No.	Item Description	Size	Bulk Qty.
R51001	Self-Drill, Pan Phil Framing #2 Point, Black Phos	#7x7/16"	10000
636304	Self-Drill, Pan Phil Framing #2 Point (Zinc CR+3)	#7x7/16"	10000



Drive Bit: PH-2

- Pan Framing Head
- Zinc Plated CR+3
- #2 Phillips Drive
- COO: Taiwan
- Black Phosphate
- Carton Color: Red

DRYWALL TO METAL - For Attaching Drywall To 14-20 Gauge Steel Studs

SELF-DRILL BUGLE HEAD

Part No.	Item Description	Size	Bulk Qty.
637010	Self-Drill, Bugle Phil #2 Point, Black Phos	#6-20x1"	10000
637020	Self-Drill, Bugle Phil #2 Point, Black Phos	#6-20x1 1/8"	10000
637030	Self-Drill, Bugle Phil #2 Point, Black Phos	#6-20x1 1/4"	8000
637040	Self-Drill, Bugle Phil #2 Point, Black Phos	#6-20x1 5/8"	5000
637050	Self-Drill, Bugle Phil #2 Point, Black Phos	#6-20x1 7/8"	4000
637060	Self-Drill, Bugle Phil #2 Point, Black Phos	#8-18x2 3/8"	2500
637070	Self-Drill, Bugle Phil #2 Point, Black Phos	#8-18x2 5/8"	1600
637080	Self-Drill, Bugle Phil #2 Point, Black Phos	#8-18x3"	1400



Drive Bit: PH-2

- Bugle Head
- COO: Taiwan
- #2 Phillips Drive
- Carton Color: Red
- Black Phosphate

DRYWALL TO METAL - For Attaching Drywall To 14-20 Gauge Steel Studs

SELF-DRILL BUGLE HEAD



Drive Bit: PH-2

- Bugle Head
- #2 Phillips Drive
- Zinc Plated CR+3
- COO: Taiwan
- Carton Color: Red

Part No.	Item Description	Size	Bulk Qty.
636350	Self-Drill, Bugle Phil, #2 Point, Zinc Plated CR+3	#6-20x1"	10000
636352	Self-Drill, Bugle Phil, #2 Point, Zinc Plated CR+3	#6-20x1 1/8"	10000
636405	Self-Drill, Bugle Phil, #2 Point, Zinc Plated CR+3	#6-20x1 1/4"	8000
636356	Self-Drill, Bugle Phil, #2 Point, Zinc Plated CR+3	#6-20x1 5/8"	5000
636358	Self-Drill, Bugle Phil, #2 Point, Zinc Plated CR+3	#6-20x1 7/8"	4000
636371	Self-Drill, Bugle Phil, #2 Point, Zinc Plated CR+3	#8-18x2 3/8"	2500
636406	Self-Drill, Bugle Phil, #2 Point, Zinc Plated CR+3	#8-18x2 5/8"	1600
636370	Self-Drill, Bugle Phil, #2 Point, Zinc Plated CR+3	#8-18x3"	1400

DRYWALL TO METAL LATH - For Attaching Drywall To 16-20 Gauge Steel Prior To Stucco

SELF-DRILL MODIFIED TRUSS



Drive Bit: PH-2

- Modified Truss Head
- #2 Phillips Drive
- Zinc Plated CR+3
- COO: Taiwan
- Carton Color: Red

Part No.	Item Description	Size	Bulk Qty.
636006	Self-Drill, Modified Truss Phil, Zinc Plated CR+3	#8-18x1/2"	10000
636009	Self-Drill, Modified Truss Phil, Zinc Plated CR+3	#8-18x9/16"	9000
636008	Self-Drill, Modified Truss Phil, Zinc Plated CR+3	#8-18x3/4"	10000
636011	Self-Drill, Modified Truss Phil, Zinc Plated CR+3	#8-18x1"	8000
636016	Self-Drill, Modified Truss Phil, Zinc Plated CR+3	#8-18x1 1/4"	6000
636020	Self-Drill, Modified Truss Phil, Zinc Plated CR+3	#8-18x1 5/8"	4000
636025	Self-Drill, Modified Truss Phil, Zinc Plated CR+3	#8-18x1 7/8"	3000
636030	Self-Drill, Modified Truss Phil, Zinc Plated CR+3	#8-18x2 1/2"	2000
636035	Self-Drill, Modified Truss Phil, Zinc Plated CR+3	#8-18x3"	1500
636102	Self-Drill, Modified Truss Phil, Zinc Plated CR+3	#10-16x3/4"	6500

PLYWOOD TO METAL - For Attaching 1/4" To 1/2" Plywood Sheeting To 14-18 Gauge Steel Studs

SELF-DRILL WAFER HEAD



Drive Bit: PH-2

- Wafer Head
- #2 Phillips Drive
- Zinc Plated CR+3
- COO: Taiwan
- Carton Color: Red

Part No.	Item Description	Size	Bulk Qty.
636510	Self-Drill, Wafer Head Phil, #3 Point CSD Zinc Plated CR+3	#10-24x3/4"	7500
636515	Self-Drill, Wafer Head Phil, #3 Point CSD Zinc Plated CR+3	#10-24x1"	5000
636520	Self-Drill, Wafer Head Phil, #3 Point CSD Zinc Plated CR+3	#10-24x1 1/2"	3000

PLYWOOD TO METAL - For Attaching 9/16" To 5/8" Plywood Sheeting To 12-18 Gauge Steel Studs

SELF-DRILL REAMER HEAD

Part No.	Item Description	Size	Bulk Qty.
636150	Self-Drill, Flat Phil Reamer BSD, Zinc Plated CR+3	#10-16x1 5/8"	3000
636155	Self-Drill, Flat Phil Reamer BSD, Zinc Plated CR+3	#12-24x2"	1500
636160	Self-Drill, Flat Phil Reamer BSD, Zinc Plated CR+3	#12-24x2 1/2"	1500
636180	Self-Drill, Flat Phil Reamer BSD, Zinc Plated CR+3	1/4"-20x2 3/4"	1000



Drive Bit: PH-2

- Reamer Head
- #2 Phillips Drive
- Zinc Plated CR+3
- COO: Taiwan
- Carton Color: Red

PLYWOOD TO METAL - For Attaching 5/8" To 3/4" Plywood Sheeting To 12-18 Gauge Steel Studs

SELF-DRILL WAFER W/ WINGS

Part No.	Item Description	Size	Bulk Qty.
636521	Self-Drill, Wafer Phil, #3 Point w/Wings CSD Zinc Pltd. CR+3	#10-24x1 7/16"	3500



Drive Bit: PH-2

- Wafer Head
- #2 Phillips Drive
- Zinc Plated CR+3
- COO: Taiwan
- Carton Color: Red

WOOD TRIM & BASE BOARD - For Attaching Wood Trim And Base Board Over Drywall To 14-20 Gauge Steel Studs

SELF-DRILL TRIM HEAD

Part No.	Item Description	Size	Bulk Qty.
636450	Self-Drill, Trim Head Square Drive, Zinc Plated CR+3	#6-20x1 5/8"	5000
636455	Self-Drill, Trim Head Square Drive, Zinc Plated CR+3	#6-20x2 1/4"	3000

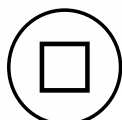

**Drive Bit:
#2 Square Drive**

- Trim Head
- #2 Square Drive
- Zinc Plated CR+3
- COO: Taiwan
- Carton Color: Red

METAL TO METAL - #6 & #8 Diameters For Light Gauge Steel And Steel Studs. #10, #12, & 1/4" Diameters For Medium Gauge Steel And Steel Studs.

SELF-DRILL HWH NON-SLOTTED



Socket / Wrench Size
Will Vary Depending On
Screw Diameter Size

- HWH (Hex Washer Head)
- Non-Slotted
- Zinc Plated CR+3
- COO: Taiwan
- Carton Color: Red

Part No.	Item Description	Size	Bulk Qty.
636200	Self-Drill, Indent HWH Non-Slotted, #2 Point, Zinc Pltd. CR+3	#6-20x3/8"	20000
636202	Self-Drill, Indent HWH Non-Slotted, #2 Point, Zinc Pltd. CR+3	#6-20x1/2"	15000
636210	Self-Drill, Indent HWH Non-Slotted, #2 Point, Zinc Pltd. CR+3	#8-18x1/2"	10000
636212	Self-Drill, Indent HWH Non-Slotted, #2 Point, Zinc Pltd. CR+3	#8-18x5/8"	10000
636216	Self-Drill, Indent HWH Non-Slotted, #2 Point, Zinc Pltd. CR+3	#8-18x3/4"	10000
636218	Self-Drill, Indent HWH Non-Slotted, #2 Point, Zinc Pltd. CR+3	#8-18x1"	7000
636220	Self-Drill, Indent HWH Non-Slotted, #2 Point, Zinc Pltd. CR+3	#8-18x1 1/4"	5000
636222	Self-Drill, Indent HWH Non-Slotted, #2 Point, Zinc Pltd. CR+3	#8-18x1 1/2"	5000
636230	Self-Drill, Indent HWH Non-Slotted, #2 Point, Zinc Pltd. CR+3	#10-16x1/2"	7000
636240	Self-Drill, Indent HWH Non-Slotted, #3 Point Zinc Pltd. CR+3	#10-16x5/8"	6000
636242	Self-Drill, Indent HWH Non-Slotted, #3 Point Zinc Pltd. CR+3	#10-16x3/4"	8000
636244	Self-Drill, Indent HWH Non-Slotted, #3 Point Zinc Pltd. CR+3	#10-16x1"	5000
636246	Self-Drill, Indent HWH Non-Slotted, #3 Point Zinc Pltd. CR+3	#10-16x1 1/4"	4000
636250	Self-Drill, Indent HWH Non-Slotted, #3 Point Zinc Pltd. CR+3	#10-16x1 1/2"	3000
636252	Self-Drill, Indent HWH Non-Slotted, #3 Point Zinc Pltd. CR+3	#10-16x2"	3000
636256	Self-Drill, Indent HWH Non-Slotted, #3 Point Zinc Pltd. CR+3	#12-14x3/4"	4000
636258	Self-Drill, Indent HWH Non-Slotted, #3 Point Zinc Pltd. CR+3	#12-14x1"	3500
636260	Self-Drill, Indent HWH Non-Slotted, #3 Point Zinc Pltd. CR+3	#12-14x1 1/4"	3000
636262	Self-Drill, Indent HWH Non-Slotted, #3 Point Zinc Pltd. CR+3	#12-14x1 1/2"	2500
636264	Self-Drill, Indent HWH Non-Slotted, #3 Point Zinc Pltd. CR+3	#12-14x2"	2000
636266	Self-Drill, Indent HWH Non-Slotted, #3 Point Zinc Pltd. CR+3	#12-14x2 1/2"	1500
636268	Self-Drill, Indent HWH Non-Slotted, #3 Point Zinc Pltd. CR+3	#12-14x3"	1000
636272	Self-Drill, Indent HWH Non-Slotted, #3 Point Zinc Pltd. CR+3	#12-14x4"	750
636280	Self-Drill, Indent HWH Non-Slotted, #3 Point Zinc Pltd. CR+3	1/4"-14x3/4"	3000
636282	Self-Drill, Indent HWH Non-Slotted, #3 Point Zinc Pltd. CR+3	1/4"-14x1"	2000
636284	Self-Drill, Indent HWH Non-Slotted, #3 Point Zinc Pltd. CR+3	1/4"-14x1 1/4"	2000
636286	Self-Drill, Indent HWH Non-Slotted, #3 Point Zinc Pltd. CR+3	1/4"-14x1 1/2"	1750
636288	Self-Drill, Indent HWH Non-Slotted, #3 Point Zinc Pltd. CR+3	1/4"-14x2"	1500
636290	Self-Drill, Indent HWH Non-Slotted, #3 Point Zinc Pltd. CR+3	1/4"-14x3"	1000

METAL TO METAL - #6 & #8 Diameters For Light Gauge Steel And Steel Studs. #10, #12, & 1/4" Diameters For Medium Gauge Steel And Steel Studs.

SELF-DRILL PAN HEAD



PH-2 Drive Bit For #6 To
#12 Diameters & PH-3 For
1/4" Diameter And Larger

- Pan Head
- Zinc Plated CR+3
- COO: Taiwan
- Carton Color: Red

Part No.	Item Description	Size	Bulk Qty.
636330	Self-Drill, Pan Phil, Zinc Plated CR+3	#6-20x3/8"	15000
636333	Self-Drill, Pan Phil, Zinc Plated CR+3	#6-20x1/2"	15000
636336	Self-Drill, Pan Phil, Zinc Plated CR+3	#6-20x5/8"	12000
636339	Self-Drill, Pan Phil, Zinc Plated CR+3	#6-20x3/4"	10000
636342	Self-Drill, Pan Phil, Zinc Plated CR+3	#8-18x3/8"	16000
636345	Self-Drill, Pan Phil, Zinc Plated CR+3	#8-18x1/2"	10000
636348	Self-Drill, Pan Phil, Zinc Plated CR+3	#8-18x5/8"	10000
636351	Self-Drill, Pan Phil, Zinc Plated CR+3	#8-18x3/4"	10000
636354	Self-Drill, Pan Phil, Zinc Plated CR+3	#8-18x1"	8000
636357	Self-Drill, Pan Phil, Zinc Plated CR+3	#8-18x1 1/2"	5000
636360	Self-Drill, Pan Phil, Zinc Plated CR+3	#10-16x1/2"	10000

METAL TO METAL - #6 & #8 Diameters For Light Gauge Steel And Steel Studs. #10, #12, & 1/4" Diameters For Medium Gauge Steel And Steel Studs

SELF-DRILL PAN HEAD



PH-2 Drive Bit For #6 To #12 Diameters & PH-3 For 1/4" Diameter And Larger

- Pan Head
- Zinc Plated CR+3
- COO: Taiwan
- Carton Color: Red

Part No.	Item Description	Size	Bulk Qty.
636363	Self-Drill, Pan Phil, Zinc Plated CR+3	#10-16x5/8"	9000
636366	Self-Drill, Pan Phil, Zinc Plated CR+3	#10-16x3/4"	8000
636369	Self-Drill, Pan Phil, Zinc Plated CR+3	#10-16x1"	5000
636372	Self-Drill, Pan Phil, Zinc Plated CR+3	#10-16x1 1/2"	3000
636375	Self-Drill, Pan Phil, Zinc Plated CR+3	#10-16x2"	2000
636378	Self-Drill, Pan Phil, Zinc Plated CR+3	#10-16x2 1/2"	2000
636381	Self-Drill, Pan Phil, Zinc Plated CR+3	#10-16x3"	1400
636384	Self-Drill, Pan Phil, Zinc Plated CR+3	#12-14x3/4"	6000
636387	Self-Drill, Pan Phil, Zinc Plated CR+3	#12-14x1"	6000
636390	Self-Drill, Pan Phil, Zinc Plated CR+3	#12-14x1 1/2"	4000
636393	Self-Drill, Pan Phil, Zinc Plated CR+3	#12-14x2"	2000
636396	Self-Drill, Pan Phil, Zinc Plated CR+3	#12-14x2 1/2"	1500
636399	Self-Drill, Pan Phil, Zinc Plated CR+3	#12-14x3"	1000
636404	Self-Drill, Pan Phil, Zinc Plated CR+3	1/4"-14x3"	1000

METAL TO METAL - For Attaching Metal Roofing And Metal Wall Panels To Steel Studs. #10, #12, & 1/4" Diameters For Medium Gauge Steel And Steel Studs

SELF-DRILL HWH NON-SLOTTED



Socket / Wrench Size Will Vary Depending On Screw Diameter Size

- HWH, Hex Washer Head
- Non-Slotted
- Zinc Plated CR+3
- COO: Taiwan
- Carton Color: Red

Part No.	Item Description	Size	Bulk Qty.
638010	Self-Drill, Indent HWH w/Bonded Washer #3 Pt. Zinc CR+3	#10-16x3/4"	3500
638015	Self-Drill, Indent HWH w/Bonded Washer #3 Pt. Zinc CR+3	#10-16x1"	3000
638020	Self-Drill, Indent HWH w/Bonded Washer #3 Pt. Zinc CR+3	#10-16x1 1/4"	2500
638025	Self-Drill, Indent HWH w/Bonded Washer #3 Pt. Zinc CR+3	#10-16x1 1/2"	2000
638030	Self-Drill, Indent HWH w/Bonded Washer #3 Pt. Zinc CR+3	#10-16x2"	1500
638050	Self-Drill, Indent HWH w/Bonded Washer #3 Pt. Zinc CR+3	#12-14x3/4"	2000
638055	Self-Drill, Indent HWH w/Bonded Washer #3 Pt. Zinc CR+3	#12-14x1"	2000
638060	Self-Drill, Indent HWH w/Bonded Washer #3 Pt. Zinc CR+3	#12-14x1 1/4"	1700
638065	Self-Drill, Indent HWH w/Bonded Washer #3 Pt. Zinc CR+3	#12-14x1 1/2"	1500
638070	Self-Drill, Indent HWH w/Bonded Washer #3 Pt. Zinc CR+3	#12-14x2"	1000
638100	Self-Drill, Indent HWH w/Bonded Washer #3 Pt. Zinc CR+3	1/4"-14x3/4"	2500
638105	Self-Drill, Indent HWH w/Bonded Washer #3 Pt. Zinc CR+3	1/4"-14x1"	2000
638110	Self-Drill, Indent HWH w/Bonded Washer #3 Pt. Zinc CR+3	1/4"-14x1 1/4"	1500
638115	Self-Drill, Indent HWH w/Bonded Washer #3 Pt. Zinc CR+3	1/4"-14x1 1/2"	1500
638120	Self-Drill, Indent HWH w/Bonded Washer #3 Pt. Zinc CR+3	1/4"-14x2"	1000

CEMENT BOARD TO WOOD - For Attaching Cement And Fiber Board To Wood And Wood Studs

FLAT HEAD COMBO-DRIVE



Drive Bit: ACR-2

Part No.	Item Description	Size	Bulk Qty.
V10010	Sharp Point, Cement Board, Combo Drive - Green Coating	#9 x 1-1/4"	5000
V10020	Sharp Point, Cement Board, Combo Drive - Green Coating	#9 x 1-5/8"	4000
V10030	Sharp Point, Cement Board, Combo Drive - Green Coating	#9 x 2-1/4"	2000

Phillips/Slotted combo drive is one of the most secure fitting drive recesses on the market, allowing installers the option of using the PH-2 ACR, (Anti Cam-Out Ribs) bit included in each box. **1500 hr. salt spray** assures longevity against corrosion with extremely fast install speeds and leaves a perfectly flush finish

CEMENT BOARD TO METAL - For Attaching Cement And Fiber Board To Steel Studs

FLAT HEAD POSI-DRIVE



Drive Bit: ACR-2

Part No.	Item Description	Size	Bulk Qty.
V10110	SDS, Cement Board, Posi-Drive - Green Coating	#8 x 1-1/4"	5000
V10120	SDS, Cement Board, Posi-Drive - Green Coating	#8 x 1-5/8"	4000
V10130	SDS, Cement Board, Posi-Drive - Green Coating	#8 x 2-1/4"	2000

Posi-Drive Cross-Recess drive is one of the most secure fitting drive recesses on the market. **1500 hr. salt spray** assures longevity against corrosion with extremely fast install speeds and leaves a perfectly flush finish

DRYWALL, SELF-DRILL, DECKING & CONCRETE SCREW BITS

DRIVE BITS

Part No.	Item Description	Size	Pkg. Qty.
• 926918	PHR-2, (Phillips Head Reduced) Drywall Screw Drive Bit	PHR-2 x 1"	20 pcs.
T50002	PH-1 Drive Bit, #1 x 1" Phillips Drive	PH-1 x 1"	20 pcs.
• T50003	PH-2 Drive Bit, #2 x 1" Phillips Drive for Self-Drill Screws	PH-2 x 1"	20 pcs.
T50004	PH-3 Drive Bit, #3 x 1" Phillips Drive	PH-3 x 1"	20 pcs.
T50006	PH-4 Drive Bit, #4 x 1" Phillips Drive	PH-4 x 1"	20 pcs.
T50009	PH-1 Drive Bit, #1 x 2" Phillips Drive	PH-1 x 2"	20 pcs.
T50010	PH-2 Drive Bit, #2 x 2" Phillips Drive	PH-2 x 2"	20 pcs.
T50011	PH-3 Drive Bit, #3 x 2" Phillips Drive	PH-2 x 2"	20 pcs.
T50100	PH-1 Drive Bit, #1 x 6" Phillips Drive	PH-1 x 6"	20 pcs.
T50101	PH-2 Drive Bit, #2 x 6" Phillips Drive	PH-2 x 6"	20 pcs.
T50102	PH-3 Drive Bit, #3 x 6" Phillips Drive	PH-3 x 6"	20 pcs.
T50103	PH-2 Drive Bit w/Stopper Collar, #2 x 1" Phillips Head	PH-2 x 1" SC	20 pcs.
♦ 906639	1" PSD2 Phil/Square Drive Bit with (ACR) Anti Cam-Out Ribs	1" Length	5 pcs.
♦ 906640	1" PSD2 Phil/Square Drive Bit with (ACR) Anti Cam-Out Ribs	1" Length	2 pcs.
♦ 906641	1" PSD2 #2 Sq. Bit w/ (ACR) Anti Cam-Out Ribs for Composite Screws	1" Length	2 pcs.
♦ 906642	2" PSD2 Phil/Square Drive Bit with (ACR) Anti Cam-Out Ribs	2" Length	5 pcs.
♦ 906643	2" PSD2 Phil/Square Drive Bit with (ACR) Anti Cam-Out Ribs	2" Length	2 pcs.
T52002	2F-3R Drive Bit, 2-3 x 1" Slotted Drive	2F-3R x 1"	20 pcs.



• Bits are suggested to properly install specific Proffered screws.
♦ ACR bits are used with Phillips combo drive screws only.

DRYWALL, SELF-DRILL, DECKING & CONCRETE SCREW BITS

DRIVE BITS

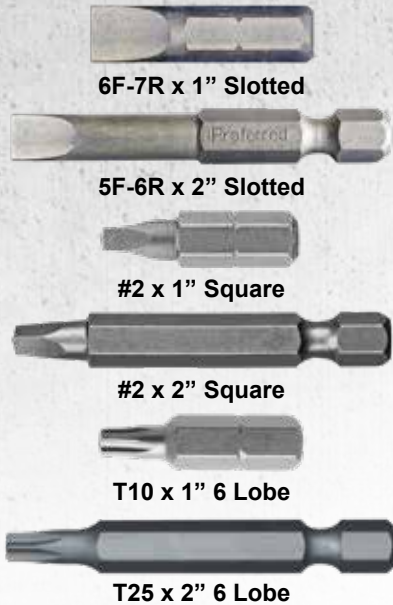

Part No.	Item Description	Size	Pkg. Qty.
T52004	4F-5R Drive Bit, 4-5 x 1" Slotted Drive	4F-5R x 1"	20 pcs.
T52005	5F-6R Drive Bit, 5-6 x 1" Slotted Drive	5F-6R x 1"	20 pcs.
T52006	6F-7R Drive Bit, 6-7 x 1" Slotted Drive	6F-7R x 1"	20 pcs.
T52007	8F-10R Drive Bit, 8-10 x 1" Slotted Drive	8F-10R x 1"	20 pcs.
T52008	10F-12R Drive Bit, 10-12 x 1" Slotted Drive	10F-12R x 1"	20 pcs.
T52009	12F-14R Drive Bit, 12-14 x 1" Slotted Drive	12F-14R x 1"	20 pcs.
T52010	14F-16R Drive Bit, 14-16 x 1" Slotted Drive	14F-16R x 1"	20 pcs.
T59100	#1 x 1" Drive Bit, Square Drive	#1 X 1"	20 pcs.
T59101	#1 x 2" Drive Bit, Square Drive	#1 X 2"	20 pcs.
T59102	#1 x 6" Drive Bit, Square Drive	#1 X 6"	20 pcs.
• T59103	#2 x 1" Drive Bit, Square Drive for Phillips Brand Deck Screws	#2 X 1"	20 pcs.
• T59104	#2 x 1" Drive Bit, Square Drive for Phillips Brand Deck Screws	#2 X 2"	20 pcs.
• T59105	#2 x 1" Drive Bit, Square Drive for Phillips Brand Deck Screws	#2 X 6"	20 pcs.
T59106	#3 x 1" Drive Bit, Square Drive	#3 X 1"	20 pcs.
T59107	#3 x 2" Drive Bit, Square Drive	#3 X 2"	20 pcs.
T59108	#3 x 6" Drive Bit, Square Drive	#3 X 6"	20 pcs.
T58100	T6 x 1" Drive Bit, 6 Lobe Star Drive	T6 X 1"	20 pcs.
T58101	T7 x 1" Drive Bit, 6 Lobe Star Drive	T7 X 1"	20 pcs.
T58102	T8 x 1" Drive Bit, 6 Lobe Star Drive	T8 X 1"	20 pcs.
T58103	T9 x 1" Drive Bit, 6 Lobe Star Drive	T9 X 1"	20 pcs.
T58104	T10 x 1" Drive Bit, 6 Lobe Star Drive	T10 X 1"	20 pcs.
T58105	T15 x 1" Drive Bit, 6 Lobe Star Drive	T15 X 1"	20 pcs.
• T58106	T20 x 1" Drive Bit, 6 Lobe Star Drive for Pro Max Deck Screws	T20 X 1"	20 pcs.
• T58107	T25 x 1" Drive Bit, 6 Lobe Star Drive for Pro Max Deck Screws	T25 X 1"	20 pcs.
T58108	T27 x 1" Drive Bit, 6 Lobe Star Drive	T27 X 1"	20 pcs.

• Bits are suggested to properly install specific Proffered screws.

DRYWALL, SELF-DRILL, DECKING & CONCRETE SCREW BITS

DRIVE BITS

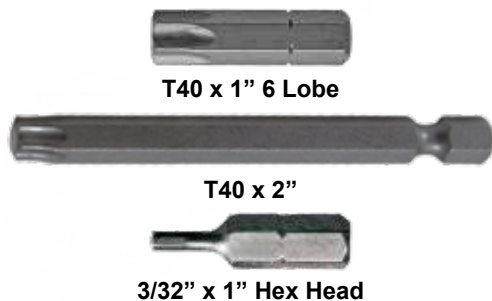

Part No.	Item Description	Size	Pkg. Qty.
T58109	T30 x 1" Drive Bit, 6 Lobe Star Drive	T30 X 1"	20 pcs.
T58110	T49 x 1" Drive Bit, 6 Lobe Star Drive	T40 X 1"	20 pcs.
T58111	T10 x 2" Drive Bit, 6 Lobe Star Drive	T10 X 2"	20 pcs.
T58112	T15 x 2" Drive Bit, 6 Lobe Star Drive	T15 X 2"	20 pcs.
T58113	T20 x 2" Drive Bit, 6 Lobe Star Drive	T20 X 2"	20 pcs.
T58114	T25 x 2" Drive Bit, 6 Lobe Star Drive	T25 X 2"	20 pcs.
T58115	T27 x 2" Drive Bit, 6 Lobe Star Drive	T27 X 2"	20 pcs.
T58116	T30 x 2" Drive Bit, 6 Lobe Star Drive	T30 X 2"	20 pcs.
T58117	T40 x 2" Drive Bit, 6 Lobe Star Drive	T40 X 2"	20 pcs.
T12100	5/64" x 1" Drive Bit, Hex Drive	5/64" X 1"	20 pcs.
T12101	3/32" x 1" Drive Bit, Hex Drive	3/32" X 1"	20 pcs.
T12102	7/64" x 1" Drive Bit, Hex Drive	7/64" X 1"	20 pcs.
T12103	1/8" x 1" Drive Bit, Hex Drive	1/8" X 1"	20 pcs.

DRYWALL, SELF-DRILL, DECKING & CONCRETE SCREW BITS

DRIVE BITS

Part No.	Item Description	Size	Pkg. Qty.
T12104	5/32" x 1" Drive Bit, Hex Drive	5/32" X 1"	20 pcs.
T12105	3/16" x 1" Drive Bit, Hex Drive	3/16" X 1"	20 pcs.
T51001	3/16" x 1-3/4" x 1/4" Magnetic Nut Setter	3/16" x 1-3/4"	5 pcs.
T51003	1/4" x 1-3/4" x 1/4" Magnetic Nut Setter	1/4" x 1-3/4"	5 pcs.
T51005	5/16" x 1-3/4" x 1/4" Magnetic Nut Setter	5/16" x 1-3/4"	5 pcs.
T51006	3/8" x 1-3/4" x 1/4" Magnetic Nut Setter	3/8" x 1-3/4"	5 pcs.
T51104	7/16" x 1-3/4" x 1/4" Magnetic Nut Setter	7/16" x 1-3/4"	5 pcs.
T51008	1/2" x 1-3/4" x 1/4" Magnetic Nut Setter	1/2" x 1-3/4"	5 pcs.
T51100	1/4" x 2-9/16" x 1/4" Magnetic Nut Setter	1/4" x 2-9/16"	5 pcs.
T51101	5/16" x 2-9/16" x 1/4" Magnetic Nut Setter	5/16" x 2-9/16"	5 pcs.
T51103	3/8" x 2-9/16" x 1/4" Magnetic Nut Setter	3/8" x 2-9/16"	5 pcs.
T51106	1/2" x 2-9/16" x 1/4" Magnetic Nut Setter	1/2" x 2-9/16"	5 pcs.
• T51107	7/16" Lag Driver w/Sleeve	7/16"	5 pcs.
T51200	1/4" x 1-3/4" Impact Nut Driver, (Magnetic)	1/4" X 1-3/4"	5 pcs.
T51201	1/4" x 2-9/16" Impact Nut Driver, (Magnetic)	1/4" X 2-9/16"	5 pcs.
T51202	1/4" x 4" Impact Nut Driver, (Magnetic)	1/4" X 4"	5 pcs.
T51203	1/4" x 6" Impact Nut Driver, (Magnetic)	1/4" X 6"	5 pcs.
T51205	5/16" x 2-9/16" Impact Nut Driver, (Magnetic)	5/16" X 2-9/16"	5 pcs.
T51206	5/16" x 4" Impact Nut Driver, (Magnetic)	5/16" X 4"	5 pcs.
T51207	5/16" x 6" Impact Nut Driver, (Magnetic)	5/16" X 6"	5 pcs.
T51208	3/8" x 1-3/4" Impact Nut Driver, (Magnetic)	3/8" X 1-3/4"	5 pcs.
T51209	3/8" x 2-9/16" Impact Nut Driver, (Magnetic)	3/8" X 2-9/16"	5 pcs.
T51210	3/8" x 4" Impact Nut Driver, (Magnetic)	3/8" X 4"	5 pcs.
T51211	3/8" x 6" Impact Nut Driver, (Magnetic)	3/8" X 6"	5 pcs.

• Bits are suggested to properly install specific Proferred screws.



5/16" x 1-3/4" Magnetic Nut Setter



1/2" x 2-9/16" Magnetic Nut Setter



3/8" x 1-3/4" Impact Nut Driver

WOOD TO WOOD - For Wood Deck, Fencing, And All Exterior Wood Applications - Bronze

MAX DRIVE DECK SCREWS

Part No.	Item Description	Size	Case Qty
V56081	Max Drive, 6 Lobe, Flat Head w/Nibs, Bronze, T-20 bit	#8 x 2"	1500
V56091	Max Drive, 6 Lobe, Flat Head w/Nibs, Bronze, T-25 bit	#9 x 2-1/2"	1400
V56092	Max Drive, 6 Lobe, Flat Head w/Nibs, Bronze, T-25 bit	#9 x 3"	1200
V56101	Max Drive, 6 Lobe, Flat Head w/Nibs, Bronze, T-25 bit	#10 x 2-1/2"	960
V56102	Max Drive, 6 Lobe, Flat Head w/Nibs, Bronze, T-25 bit	#10 x 3"	840
V56103	Max Drive, 6 Lobe, Flat Head w/Nibs, Bronze, T-25 bit	#10 x 3-1/2"	720
V56104	Max Drive, 6 Lobe, Flat Head w/Nibs, Bronze, T-25 bit	#10 x 4"	600



Drive Bit:
T20 6 Lobe For #8 Diameter Screws
T25 6 Lobe For #9 & #10 Diameter Screws

- Requires no pre-drilling • Compatible for ACQ treated lumber
- SKT coating - 1,500 hour salt spray • For use in all exterior wood applications
- 6 lobe drive recess provides tighter bit engagement, assuring you have maximum drive torque throughout the entire job with no cam-outs
- Sharp points and serrated thread design allows for extremely fast penetration and overall installation, saving you time and money
- Sold in 3 lb. plastic jars with quick release lid for ease of product access. Sold in full case quantities only, 4 jars per case

WOOD TO WOOD - For Wood Deck, Fencing, And All Exterior Wood Applications - 305 Stainless Steel

MAX DRIVE DECK SCREWS

Part No.	Item Description	Size	Case Qty
V57081	Max Drive, 6 Lobe, Flat Head w/Nibs, 305 Stainless Steel, T-20 bit	#8 x 2"	1500
V57091	Max Drive, 6 Lobe, Flat Head w/Nibs, 305 Stainless Steel, T-25 bit	#9 x 2-1/2"	1400
V57092	Max Drive, 6 Lobe, Flat Head w/Nibs, 305 Stainless Steel, T-25 bit	#9 x 3"	1200
V57101	Max Drive, 6 Lobe, Flat Head w/Nibs, 305 Stainless Steel, T-25 bit	#10 x 2-1/2"	960
V57102	Max Drive, 6 Lobe, Flat Head w/Nibs, 305 Stainless Steel, T-25 bit	#10 x 3"	840
V57103	Max Drive, 6 Lobe, Flat Head w/Nibs, 305 Stainless Steel, T-25 bit	#10 x 3-1/2"	720
V57104	Max Drive, 6 Lobe, Flat Head w/Nibs, 305 Stainless Steel, T-25 bit	#10 x 4"	600



Drive Bit:
T20 6 Lobe For #8 Diameter Screws
T25 6 Lobe For #9 & #10 Diameter Screws

- Requires no pre-drilling • Compatible for ACQ treated lumber
- 305 stainless steel provides additional corrosion protection • For use in all exterior wood applications
- 6 lobe drive recess provides tighter bit engagement, assuring you have maximum drive torque throughout the entire job with no cam-outs
- Sharp points and serrated thread design allows for extremely fast penetration and overall installation, saving you time and money
- Sold in 3 lb. plastic jars with quick release lid for ease of product access. Sold in full case quantities only, 4 jars per case



Proffered **MAX DRIVE**
Designed for Ultimate Performance

Professional Decking & Outdoors Wood Screws
 Tornillos profesional para aplicaciones de madera

ITEM NO. V56104

BRONZE BRONCEADO

#10 x 4"

3 LBS
150 PCS

FREE
 BIT INCLUDED
 BROCA DE 6
 LOBULOS INCLUIDA

6 lobe drive recess provides tight bit engagement, assuring you have maximum drive torque throughout the entire job.
 El resaca de 6 lobos proporciona un acoplamiento apriete asegurado, lo que garantiza que tenga máximo torque durante todo el trabajo.

Sharp points and serrated thread design allows for extremely fast penetration and overall installation.
 Puntas afiladas y diseño de rosca dentada permiten una penetración extremadamente rápida.

SKT Coating® approved for ACO treated woods and high anti-corrosion offering up to 1500 hours salt spray resistance.
 SKT Coating® aprobado para madera tratada ACO, contra la corrosión hasta 1500 horas Niebla de sal.

Lot No. W19B6035

WOOD TO WOOD - For Installing Wood Decking, Fencing, And All Wood Applications - Tan

DECK SCREWS



Drive Bit:
PH-2-2 or ACR-2

Part No.	Item Description	Size	Case Qty
P55010	Phillips Combo Drive Deck Screws, 1lb. #2 Phil ACR or #2 Sq. Drive Bit	#7 x 1 1/4"	25
P55020	Phillips Combo Drive Deck Screws, 1lb. #2 Phil ACR or #2 Sq. Drive Bit	#8 x 1 5/8"	25
P55030	Phillips Combo Drive Deck Screws, 1lb. #2 Phil ACR or #2 Sq. Drive Bit	#9 x 2"	25
P55035	Phillips Combo Drive Deck Screws, 1lb. #2 Phil ACR or #2 Sq. Drive Bit	#9 x 2 1/2"	25
P55040	Phillips Combo Drive Deck Screws, 1lb. #2 Phil ACR or #2 Sq. Drive Bit	#9 x 3"	25
P55045	Phillips Combo Drive Deck Screws, 1lb. #2 Phil ACR or #2 Sq. Drive Bit	#9 x 3 1/2"	25
P55020	Phillips Combo Drive Deck Screws, 5lb. #2 Phil ACR or #2 Sq. Drive Bit	#8 x 1 5/8"	8
P55030	Phillips Combo Drive Deck Screws, 5lb. #2 Phil ACR or #2 Sq. Drive Bit	#9 x 2"	8
P55035	Phillips Combo Drive Deck Screws, 5lb. #2 Phil ACR or #2 Sq. Drive Bit	#9 x 2 1/2"	8
P55040	Phillips Combo Drive Deck Screws, 5lb. #2 Phil ACR or #2 Sq. Drive Bit	#9 x 3"	8
P55045	Phillips Combo Drive Deck Screws, 5lb. #2 Phil ACR or #2 Sq. Drive Bit	#9 x 3 1/2"	8
P55020	Phillips Combo Drive Deck Screws, 25lb. #2 Phil ACR or #2 Sq. Drive Bit	#8 x 1 5/8"	1
P55035	Phillips Combo Drive Deck Screws, 25lb. #2 Phil ACR or #2 Sq. Drive Bit	#9 x 2 1/2"	1
P55040	Phillips Combo Drive Deck Screws, 25lb. #2 Phil ACR or #2 Sq. Drive Bit	#9 x 3"	1

- Phillips square drive with ACR[®] • Double head transition • Durafast[®] proprietary coating
- Compatible for ACQ treated lumber • ACR, anti cam-out ribs on drive bit and inside screw recess
- Head recess that won't strip or cam-out even in hard woods • Off angle driveability
- 35% more steel under the screw head where most screws snap
- Durafast[®] offers exceptional corrosive resistance against moisture and wood enzymes that will not rust • Sold in full case quantities only

WOOD TO WOOD - For Installing Wood Decking, Fencing, And All Wood Applications - Red

DECK SCREWS



Drive Bit:
PH-2-2 or ACR-2

Part No.	Item Description	Size	Case Qty
P56010	Phillips Combo Drive Deck Screws, 1lb. #2 Phil ACR or #2 Sq. Drive Bit	#7 x 1 1/4"	25
P56020	Phillips Combo Drive Deck Screws, 1lb. #2 Phil ACR or #2 Sq. Drive Bit	#8 x 1 5/8"	25
P56030	Phillips Combo Drive Deck Screws, 1lb. #2 Phil ACR or #2 Sq. Drive Bit	#9 x 2"	25
P56035	Phillips Combo Drive Deck Screws, 1lb. #2 Phil ACR or #2 Sq. Drive Bit	#9 x 2 1/2"	25
P56040	Phillips Combo Drive Deck Screws, 1lb. #2 Phil ACR or #2 Sq. Drive Bit	#9 x 3"	25
P56045	Phillips Combo Drive Deck Screws, 1lb. #2 Phil ACR or #2 Sq. Drive Bit	#9 x 3 1/2"	25
P56020	Phillips Combo Drive Deck Screws, 5lb. #2 Phil ACR or #2 Sq. Drive Bit	#8 x 1 5/8"	8
P56030	Phillips Combo Drive Deck Screws, 5lb. #2 Phil ACR or #2 Sq. Drive Bit	#9 x 2"	8
P56035	Phillips Combo Drive Deck Screws, 5lb. #2 Phil ACR or #2 Sq. Drive Bit	#9 x 2 1/2"	8
P56040	Phillips Combo Drive Deck Screws, 5lb. #2 Phil ACR or #2 Sq. Drive Bit	#9 x 3"	8
P56045	Phillips Combo Drive Deck Screws, 5lb. #2 Phil ACR or #2 Sq. Drive Bit	#9 x 3 1/2"	8
P56020	Phillips Combo Drive Deck Screws, 25lb. #2 Phil ACR or #2 Sq. Drive Bit	#8 x 1 5/8"	1
P56035	Phillips Combo Drive Deck Screws, 25lb. #2 Phil ACR or #2 Sq. Drive Bit	#9 x 2 1/2"	1
P56040	Phillips Combo Drive Deck Screws, 25lb. #2 Phil ACR or #2 Sq. Drive Bit	#9 x 3"	1

- Phillips square drive with ACR[®] • Double head transition • Durafast[®] proprietary coating
- Compatible for ACQ treated lumber • ACR, anti cam-out ribs on drive bit and inside screw recess
- Head recess that won't strip or cam-out even in hard woods • Off angle driveability
- 35% more steel under the screw head where most screws snap
- Durafast[®] offers exceptional corrosive resistance against moisture and wood enzymes that will not rust • Sold in full case quantities only

WOOD TO WOOD - For Installing Wood Decking, Fencing, And All Wood Applications - Green

DECK SCREWS



**Drive Bit:
PH-2-2 or ACR-2**

Part No.	Item Description	Size	Case Qty
P54010	Phillips Combo Drive Deck Screws, 1lb. #2 Phil ACR or #2 Sq. Drive Bit	#7 x 1 1/4"	25
P54015	Phillips Combo Drive Deck Screws, 1lb. #2 Phil ACR or #2 Sq. Drive Bit	#8 x 1 5/8"	25
P54020	Phillips Combo Drive Deck Screws, 1lb. #2 Phil ACR or #2 Sq. Drive Bit	#9 x 2"	25
P54025	Phillips Combo Drive Deck Screws, 1lb. #2 Phil ACR or #2 Sq. Drive Bit	#9 x 2 1/2"	25
P54030	Phillips Combo Drive Deck Screws, 1lb. #2 Phil ACR or #2 Sq. Drive Bit	#9 x 3"	25
P54035	Phillips Combo Drive Deck Screws, 1lb. #2 Phil ACR or #2 Sq. Drive Bit	#9 x 3 1/2"	25
P54040	Phillips Combo Drive Deck Screws, 1lb. #2 Phil ACR or #2 Sq. Drive Bit	#9 x 4"	25
P54010	Phillips Combo Drive Deck Screws, 5lb. #2 Phil ACR or #2 Sq. Drive Bit	#7 x 1 1/4"	8
P54015	Phillips Combo Drive Deck Screws, 5lb. #2 Phil ACR or #2 Sq. Drive Bit	#8 x 1 5/8"	8
P54020	Phillips Combo Drive Deck Screws, 5lb. #2 Phil ACR or #2 Sq. Drive Bit	#9 x 2"	8
P54025	Phillips Combo Drive Deck Screws, 5lb. #2 Phil ACR or #2 Sq. Drive Bit	#9 x 2 1/2"	8
P54030	Phillips Combo Drive Deck Screws, 5lb. #2 Phil ACR or #2 Sq. Drive Bit	#9 x 3"	8
P54035	Phillips Combo Drive Deck Screws, 5lb. #2 Phil ACR or #2 Sq. Drive Bit	#9 x 3 1/2"	8
P54040	Phillips Combo Drive Deck Screws, 5lb. #2 Phil ACR or #2 Sq. Drive Bit	#9 x 4"	8
P54015	Phillips Combo Drive Deck Screws, 25lb. #2 Phil ACR or #2 Sq. Drive Bit	#8 x 1 5/8"	1
P54020	Phillips Combo Drive Deck Screws, 25lb. #2 Phil ACR or #2 Sq. Drive Bit	#9 x 2"	1
P54025	Phillips Combo Drive Deck Screws, 25lb. #2 Phil ACR or #2 Sq. Drive Bit	#9 x 2 1/2"	1
P54030	Phillips Combo Drive Deck Screws, 25lb. #2 Phil ACR or #2 Sq. Drive Bit	#9 x 3"	1

- Phillips square drive with ACR[®] • Double head transition • Durafast[®] proprietary coating
- Compatible for ACQ treated lumber • ACR, anti cam-out ribs on drive bit and inside screw recess
- Head recess that won't strip or cam-out even in hard woods • Off angle driveability
- 35% more steel under the screw head where most screws snap
- Durafast[®] offers exceptional corrosive resistance against moisture and wood enzymes that will not rust • Sold in full case quantities only

For Installing Composite Decking - Available In Gray, Tan & Red

DECK SCREWS

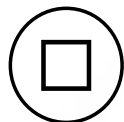

**Drive Bit:
#2 Square Drive**

Part No.	Item Description	Size	Case Qty.
P61647	Square Drive Composite Deck Screws, 5lb. - Gray	#10 x 2 1/2"	8
P61647	Square Drive Composite Deck Screws, 25lb. - Gray	#10 x 2 1/2"	1
P61656	Square Drive Composite Deck Screws, 5lb. - Gray	#10 x 3"	8
P61656	Square Drive Composite Deck Screws, 25lb. - Gray	#10 x 3"	1
P61648	Square Drive Composite Deck Screws, 5lb. -Tan	#10 x 2 1/2"	8
P61648	Square Drive Composite Deck Screws, 25lb. - Tan	#10 x 2 1/2"	1
P61660	Square Drive Composite Deck Screws, 5lb. -Tan	#10 x 3"	8
P61660	Square Drive Composite Deck Screws, 25lb. - Tan	#10 x 3"	1
P61649	Square Drive Composite Deck Screws, 5lb. - Red	#10 x 2 1/2"	8
P61649	Square Drive Composite Deck Screws, 25lb. - Red	#10 x 2 1/2"	1
P61658	Square Drive Composite Deck Screws, 5lb. - Red	#10 x 3"	8
P61658	Square Drive Composite Deck Screws, 25lb. - Red	#10 x 3"	1

- Patented thread design reduces mushrooming, pulling materials inward, leaving a clean smooth partical free finish • Durafast[®] patent finish will not rust
- Small head design presents a clean, great finished look

WOOD TO WOOD - For Installing Wood Decks, Fencing, And Other Wood Projects

DECK SCREWS

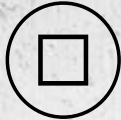

**Drive Bit:
#2, #3 Square Drive**

Part No.	Item Description	Size	Case Qty.
V02313	Stainless 18-8, Bugle Head - Square Drive Deck Screws, Type-17 Pt.	#8-8 x 1-1/4"	4,000
V02315	Stainless 18-8, Bugle Head - Square Drive Deck Screws, Type-17 Pt.	#8-8 x 1-1/2"	3,000
V02317	Stainless 18-8, Bugle Head - Square Drive Deck Screws, Type-17 Pt.	#8-8 x 1-5/8"	3,000
V02321	Stainless 18-8, Bugle Head - Square Drive Deck Screws, Type-17 Pt.	#8-8 x 2"	2,500
V02323	Stainless 18-8, Bugle Head - Square Drive Deck Screws, Type-17 Pt.	#8-8 x 2-1/4"	2,000
V02325	Stainless 18-8, Bugle Head - Square Drive Deck Screws, Type-17 Pt.	#8-8 x 2-1/2"	2,000
V02327	Stainless 18-8, Bugle Head - Square Drive Deck Screws, Type-17 Pt.	#8-8 x 2-3/4"	1,500
V02331	Stainless 18-8, Bugle Head - Square Drive Deck Screws, Type-17 Pt.	#8-8 x 3"	1,500
V02435	Stainless 18-8, Bugle Head - Square Drive Deck Screws, Type-17 Pt.	#10-8 x 2"	2,000
V02436	Stainless 18-8, Bugle Head - Square Drive Deck Screws, Type-17 Pt.	#10-8 x 2-1/4"	1,500
V02437	Stainless 18-8, Bugle Head - Square Drive Deck Screws, Type-17 Pt.	#10-8 x 2-1/2"	1,500
V02438	Stainless 18-8, Bugle Head - Square Drive Deck Screws, Type-17 Pt.	#10-8 x 2-3/4"	1,400
V02439	Stainless 18-8, Bugle Head - Square Drive Deck Screws, Type-17 Pt.	#10-8 x 3"	1,200
V02440	Stainless 18-8, Bugle Head - Square Drive Deck Screws, Type-17 Pt.	#10-8 x 3-1/2"	1,000
V02441	Stainless 18-8, Bugle Head - Square Drive Deck Screws, Type-17 Pt.	#10-8 x 4"	1,000
V02505	Stainless 18-8, Bugle Head - Square Drive Deck Screws, Type-17 Pt.	#12-7 x 2"	1,200
V02506	Stainless 18-8, Bugle Head - Square Drive Deck Screws, Type-17 Pt.	#12-7 x 2-1/2"	1,200
V02507	Stainless 18-8, Bugle Head - Square Drive Deck Screws, Type-17 Pt.	#12-7 x 3"	1,000
V02508	Stainless 18-8, Bugle Head - Square Drive Deck Screws, Type-17 Pt.	#12-7 x 4"	800
V02509	Stainless 18-8, Bugle Head - Square Drive Deck Screws, Type-17 Pt.	#12-7 x 4-1/2"	600
V02510	Stainless 18-8, Bugle Head - Square Drive Deck Screws, Type-17 Pt.	#12-7 x 5"	600
V02611	Stainless 18-8, Bugle Head - Square Drive Deck Screws, Type-17 Pt.	#14-7 x 6"	350

- Type-17 point for fast penetration • Square drive recess assures less cam-outs and less fatigue
- 18-8 stainless for superior corrosion resistance

WOOD TO WOOD - For Installing Wood Decks, Fencing, And Other Wood Projects

DECK SCREWS

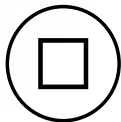

**Drive Bit:
#2 Square Drive**

Part No.	Item Description	Size	Case Qty.
V04116	Stainless 18-8, Bugle Head - Square Drive Deck Screws w/Nibs, Type-17	#6-9 X 1-5/8"	3,500
V04313	Stainless 18-8, Bugle Head - Square Drive Deck Screws w/Nibs, Type-17	#8-8 x 1-1/4"	4,000
V04315	Stainless 18-8, Bugle Head - Square Drive Deck Screws w/Nibs, Type-17	#8-8 X 1-1/2"	3,000
V04317	Stainless 18-8, Bugle Head - Square Drive Deck Screws w/Nibs, Type-17	#8-8 X 1-5/8"	3,000
V04319	Stainless 18-8, Bugle Head - Square Drive Deck Screws w/Nibs, Type-17	#8-8 X 1-3/4"	3,000
V04321	Stainless 18-8, Bugle Head - Square Drive Deck Screws w/Nibs, Type-17	#8-8 X 2"	2,500
V04325	Stainless 18-8, Bugle Head - Square Drive Deck Screws w/Nibs, Type-17	#8-8 X 2-1/2"	2,000
V04331	Stainless 18-8, Bugle Head - Square Drive Deck Screws w/Nibs, Type-17	#8-8 X 3"	1,500
V04437	Stainless 18-8, Bugle Head - Square Drive Deck Screws w/Nibs, Type-17	#10-8 X 2-1/2"	1,500
V04439	Stainless 18-8, Bugle Head - Square Drive Deck Screws w/Nibs, Type-17	#10-8 X 3"	1,200
V04440	Stainless 18-8, Bugle Head - Square Drive Deck Screws w/Nibs, Type-17	#10-8 X 3-1/2"	1,000

- Type-17 point for fast penetration • Square drive recess assures less cam-outs and less fatigue
- 18-8 stainless for superior corrosion resistance

WOOD TO WOOD - For Installing Wood Decks, Fencing, And Other Wood Projects

DECK SCREWS



Drive Bit: PH-2

Part No.	Item Description	Size	Case Qty.
V03116	Stainless 18-8, Bugle Head - #2 Phillips Drive Deck Screws, Type-17 Pt.	#6-9 x 1-5/8"	3,500
V03317	Stainless 18-8, Bugle Head - #2 Phillips Drive Deck Screws, Type-17 Pt.	#8-8 x 1-5/8"	3,000
V03321	Stainless 18-8, Bugle Head - #2 Phillips Drive Deck Screws, Type-17 Pt.	#8-8 x 2"	2,500
V03323	Stainless 18-8, Bugle Head - #2 Phillips Drive Deck Screws, Type-17 Pt.	#8-8 x 2-1/4"	2,000
V03325	Stainless 18-8, Bugle Head - #2 Phillips Drive Deck Screws, Type-17 Pt.	#8-8 x 2-1/2"	2,000
V03331	Stainless 18-8, Bugle Head - #2 Phillips Drive Deck Screws, Type-17 Pt.	#8-8 x 3"	1,500
V03437	Stainless 18-8, Bugle Head - #2 Phillips Drive Deck Screws, Type-17 Pt.	#10-8 x 2-1/2"	1,500
V03439	Stainless 18-8, Bugle Head - #2 Phillips Drive Deck Screws, Type-17 Pt.	#10-8 x 3"	1,200
V03440	Stainless 18-8, Bugle Head - #2 Phillips Drive Deck Screws, Type-17 Pt.	#10-8 x 3-1/2"	1,000

• Type-17 point for fast penetration • 18-8 stainless for superior corrosion resistance

WOOD TO WOOD - For Installing Wood Decks, Fencing, And Other Wood Projects

DECK SCREWS

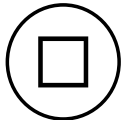

**Drive Bit:
#2, #3 Square Drive**

Part No.	Item Description	Size	Case Qty.
V05433	Stainless 316, Bugle Head - Square Drive Deck Screws, Type-17 Pt.	#10-8 x 1-5/8"	2,500
V05435	Stainless 316, Bugle Head - Square Drive Deck Screws, Type-17 Pt.	#10-8 x 2"	2,000
V05437	Stainless 316, Bugle Head - Square Drive Deck Screws, Type-17 Pt.	#10-8 x 2-1/2"	1,500
V05439	Stainless 316, Bugle Head - Square Drive Deck Screws, Type-17 Pt.	#10-8 x 3"	1,200
V05440	Stainless 316, Bugle Head - Square Drive Deck Screws, Type-17 Pt.	#10-8 x 3-1/2"	1,000
V05507	Stainless 316, Bugle Head - Square Drive Deck Screws, Type-17 Pt.	#12-7 x 3"	1,000
V05508	Stainless 316, Bugle Head - Square Drive Deck Screws, Type-17 Pt.	#12-7 x 4"	800
V05509	Stainless 316, Bugle Head - Square Drive Deck Screws, Type-17 Pt.	#12-7 x 4-1/2"	600
V05510	Stainless 316, Bugle Head - Square Drive Deck Screws, Type-17 Pt.	#12-7 x 5"	600
V05607	Stainless 316, Bugle Head - Square Drive Deck Screws, Type-17 Pt.	#14-7 x 3"	600
V05608	Stainless 316, Bugle Head - Square Drive Deck Screws, Type-17 Pt.	#14-7 x 4"	500
V05610	Stainless 316, Bugle Head - Square Drive Deck Screws, Type-17 Pt.	#14-7 x 5"	400
V05611	Stainless 316, Bugle Head - Square Drive Deck Screws, Type-17 Pt.	#14-7 x 6"	350

• Type-17 point for fast penetration • Square drive recess assures less cam-outs and less fatigue
• 316 stainless for superior corrosion resistance

METAL TO METAL - For Holding Two Or More Pieces Of Material Together Typically In Sheet Metal Applications.

LARGE DOME HEAD BLIND RIVET



- IFI-114, Style 2, Grade 30
- IFI-114, Style 2, Grade 11
- IFI-114, Style 2, Grade 19
- Body Diameters: 1/8" thru 8/16"
- Grip Range: 0.063" thru 1"

Part No.	Item Description	Size	Bulk Qty.
034001	Steel / Steel	4-2L 1/8 (.063-.125) x 0.250	10000
034002	Steel / Steel	4-3L 1/8 (.126-.187) x 0.313	10000
034003	Steel / Steel	4-4L 1/8 (.188-.250) x 0.375	10000
034004	Steel / Steel	4-6L 1/8 (.313-.375) x 0.500	8000
034005	Steel / Steel	5-4L 5/32 (.188-.250) x 0.425	5000
034006	Steel / Steel	6-4L 3/16 (.188-.250) x 0.425	3000
034007	Steel / Steel	6-6L 3/16 (.251-.375) x 0.550	3000
034008	Steel / Steel	6-8L 3/16 (.376-.500) x 0.675	2500
034009	Steel / Steel	6-10L 3/16 (.501-.625) x 0.800	2000
034010	Steel / Steel	6-12L 3/16 (.626-.750) x 0.925	2000
034011	Steel / Steel	6-16L 3/16 (.876-1.000) x 1.2	1500
034012	Steel / Steel	8-4L 1/4 (.126-.250) x 0.475	1000
034013	Steel / Steel	8-6L 1/4 (.251-.375) x 0.600	1000
034014	Steel / Steel	8-8L 1/4 (.376-.500) x 0.725	1000
034015	Steel / Steel	8-10L 1/4 (.501-.625) x 0.850	1000
034016	Steel / Steel	8-12L 1/4 (.626-.750) x 0.975	1000
035001	Aluminum / Aluminum	4-2L 1/8 (.063-.125) x 0.250	10000
035002	Aluminum / Aluminum	4-3L 1/8 (.126-.187) x 0.313	10000
035003	Aluminum / Aluminum	4-4L 1/8 (.188-.250) x 0.375	10000
035004	Aluminum / Aluminum	4-6L 1/8 (.313-.375) x 0.500	8000
035005	Aluminum / Aluminum	5-4L 5/32 (.188-.250) x 0.425	5000
035006	Aluminum / Aluminum	6-4L 3/16 (.188-.250) x 0.425	3000
035007	Aluminum / Aluminum	6-6L 3/16 (.251-.375) x 0.550	3000
035008	Aluminum / Aluminum	6-8L 3/16 (.376-.500) x 0.675	2500
035009	Aluminum / Aluminum	6-10L 3/16 (.501-.625) x 0.800	2000
035010	Aluminum / Aluminum	6-12L 3/16 (.626-.750) x 0.925	2000
036001	AL5056 / Steel	4-2L 1/8 (.063-.125) x 0.250	10000
036002	AL5056 / Steel	4-3L 1/8 (.126-.187) x 0.313	10000
036003	AL5056 / Steel	4-4L 1/8 (.188-.250) x 0.375	10000
036004	AL5056 / Steel	6-4L 3/16 (.188-.250) x 0.425	3000
036005	AL5056 / Steel	6-6L 3/16 (.251-.375) x 0.550	3000
036006	AL5056 / Steel	6-8L 3/16 (.376-.500) x 0.675	2500
036007	AL5056 / Steel	6-10L 3/16 (.501-.625) x 0.800	2000
036008	AL5056 / Steel	6-12L 3/16 (.626-.750) x 0.925	2000
036009	AL5056 / Steel	6-14L 3/16 (.751-.875) x 1.075	1500
036010	AL5056 / Steel	6-16L 3/16 (.876-1.000) x 1.2	1500
036011	AL5056 / Steel	5-4L 5/32 (.188-.250) x 0.400	5000
036012	AL5056 / Steel	4-6L 1/8 (.313-.375)	10000

Increased flanged diameter perfect for soft or brittle material.

METAL TO METAL - For Holding Two Or More Pieces Of Material Together Typically In Sheet Metal Applications.

LARGE DOME HEAD BLIND RIVET



- IFI-114, Style 2, Grade 51
- Body Diameters: 1/8" thru 3/16"
- Grip Range: 0.031" thru 1"

Part No.	Item Description	Size	Bulk Qty.
037001	Stainless 304 / Stainless 304	4-2L 1/8 (.063-.125) x 0.250	10000
037002	Stainless 304 / Stainless 304	4-3L 1/8 (.126-.187) x 0.313	10000
037003	Stainless 304 / Stainless 304	4-4L 1/8 (.188-.250) x 0.375	10000
037004	Stainless 304 / Stainless 304	4-6L 1/8 (.313-.375) x 0.500	8000
037005	Stainless 304 / Stainless 304	6-4L 3/16 (.188-.250) x 0.425	3000
037006	Stainless 304 / Stainless 304	6-6L 3/16 (.251-.375) x 0.550	3000
037007	Stainless 304 / Stainless 304	6-8L 3/16 (.376-.500) x 0.675	2500
037008	Stainless 304 / Stainless 304	6-10L 3/16(.501-.625) x 0.800	2000
037009	Stainless 304 / Stainless 304	6-12L 3/16(.626-.750) x 0.925	2000
037010	Stainless 304 / Stainless 304	4-5L 1/8 (.251-.312) x 0.462	8000
037011	Stainless 304 / Stainless 304	5-2L 5/32 (.031-.125) x 0.300	6000
037012	Stainless 304 / Stainless 304	5-4L 5/32 (.188-.250) x 0.425	5000
037013	Stainless 304 / Stainless 304	5-6L 5/32 (.251-.375) x 0.550	5000
037014	Stainless 304 / Stainless 304	5-8L 5/32 (.376-.500) x 0.675	5000
037015	Stainless 304 / Stainless 304	6-2L 3/16 (.031-.125) x 0.300	3000
037016	Stainless 304 / Stainless 304	6-16L 3/16 (.876-1.000) x 1.2	1500

Increased flanged diameter perfect for soft or brittle material.

METAL TO METAL - For Holding Two Or More Pieces Of Material Together Typically In Sheet Metal Applications.

COUNTERSUNK BLIND RIVET



- IFI-114 Grade 30
- IFI-114 Grade 11
- Body Diameters: 1/8" thru 3/16"
- Grip Range: 0.092" thru 0.500"

Part No.	Item Description	Size	Bulk Qty.
100001	Steel / Steel Zinc CR+3	4-2 1/8 (.092-.125) x 0.250	10000
100002	Steel / Steel Zinc CR+3	4-3 1/8 (.126-.187) x 0.313	10000
100003	Steel / Steel Zinc CR+3	4-4 1/8 (.188-.250) x 0.375	10000
100004	Steel / Steel Zinc CR+3	4-6 1/8 (.313-.375) x 0.500	10000
100005	Steel / Steel Zinc CR+3	4-8 1/8 (.376-.500) x 0.625	10000
100006	Steel / Steel Zinc CR+3	5-4 5/32 (.188-.250) x 0.400	8000
100007	Steel / Steel Zinc CR+3	6-4 3/16 (.188-.250) x 0.425	5000
100008	Steel / Steel Zinc CR+3	6-6 3/16 (.251-.375) x 0.550	5000
100009	Steel / Steel Zinc CR+3	6-8 3/16 (.376-.500) x 0.675	4000
132001	Aluminum / Aluminum	4-2 1/8 (.092-.125) x 0.250	10000
132002	Aluminum / Aluminum	4-3 1/8 (.126-.187) x 0.313	10000
132003	Aluminum / Aluminum	4-4 1/8 (.188-.250) x 0.375	10000
132004	Aluminum / Aluminum	4-6 1/8 (.313-.375) x 0.500	10000
132005	Aluminum / Aluminum	5-4 5/32 (.188-.250) x 0.400	8000
132006	Aluminum / Aluminum	5-6 5/32 (.251-.375) x 0.525	6000
132007	Aluminum / Aluminum	6-4 3/16 (.188-.250) x 0.425	5000
132008	Aluminum / Aluminum	6-6 3/16 (.251-.375) x 0.550	5000
132009	Aluminum / Aluminum	6-8 3/16 (.376-.500) x 0.675	4000

Suitable for those applications where a flat surface is needed after installation, where zero gap distance is required between the fastener and the surfaces being fastened.

METAL TO METAL - For Holding Two Or More Pieces Of Material Together Typically In Sheet Metal Applications.

COUNTERSUNK BLIND RIVET

Part No.	Item Description	Size	Bulk Qty.
134001	AL5056 Aluminum / Steel	4-2 1/8 (.092-.125) x 0.250	10000
134002	AL5056 Aluminum / Steel	4-3 1/8 (.126-.187) x 0.313	10000
134003	AL5056 Aluminum / Steel	4-4 1/8 (.188-.250) x 0.375	10000
134004	AL5056 Aluminum / Steel	4-5 1/8 (.251-.312) x 0.438	10000
134005	AL5056 Aluminum / Steel	5-4 5/32 (.188-.250) x 0.400	8000
134006	AL5056 Aluminum / Steel	5-6 5/32 (.251-.375) x 0.525	6000
134007	AL5056 Aluminum / Steel	5-8 5/32 (.376-.500) x 0.650	6000
134008	AL5056 Aluminum / Steel	6-4 3/16 (.188-.250) x 0.425	5000
134009	AL5056 Aluminum / Steel	6-6 3/16 (.251-.375) x 0.550	5000
134010	AL5056 Aluminum / Steel	6-8 3/16 (.376-.500) x 0.675	4000
137001	Stainless 304 / Steel	4-2 1/8 (.092-.125) x 0.250	10000
137002	Stainless 304 / Steel	4-3 1/8 (.126-.187) x 0.313	10000
137003	Stainless 304 / Steel	4-4 1/8 (.188-.250) x 0.375	10000
137004	Stainless 304 / Steel	4-5 1/8 (.251-.312) x 0.438	10000
137005	Stainless 304 / Steel	6-4 3/16 (.188-.250) x 0.425	5000
136001	Stainless / Stainless	4-2 1/8 (.092-.125) x 0.250	10000
136002	Stainless / Stainless	4-3 1/8 (.126-.187) x 0.313	10000
136003	Stainless / Stainless	4-4 1/8 (.188-.250) x 0.375	10000
136004	Stainless / Stainless	4-5 1/8 (.251-.312) x 0.438	10000
136005	Stainless / Stainless	6-4 3/16 (.188-.250) x 0.425	5000
136006	Stainless / Stainless	6-6 3/16 (.251-.375) x 0.550	5000
136007	Stainless / Stainless	6-8 3/16 (.376-.500) x 0.675	5000

Suitable for those applications where a flat surface is needed after installation, where zero gap distance is required between the fastener and the surfaces being fastened.



- IFI-114 Grade 19
- IFI-114 Grade 50
- IFI-114 Grade 51
- Body Diameters: 1/8" thru 3/16"
- Grip Range: 0.092" thru 0.500"

METAL TO METAL - For Holding Two Or More Pieces Of Material Together Typically In Sheet Metal Applications.

DOME HEAD BLIND RIVET

Part No.	Item Description	Size	Bulk Qty.
183001	Steel / Steel Zinc CR+3	4-2 1/8 (.063-.125) x 0.250	10000
183002	Steel / Steel Zinc CR+3	4-3 1/8 (.126-.187) x 0.313	10000
183003	Steel / Steel Zinc CR+3	4-4 1/8 (.188-.250) x 0.375	10000
183004	Steel / Steel Zinc CR+3	4-6 1/8 (.313-.375) x 0.500	10000
183005	Steel / Steel Zinc CR+3	4-8 1/8 (.376-.500) x 0.625	10000
183006	Steel / Steel Zinc CR+3	6-2 3/16 (.031-.125) x 0.300	5000
183007	Steel / Steel Zinc CR+3	6-4 3/16 (.188-.250) x 0.425	5000
183008	Steel / Steel Zinc CR+3	6-6 3/16 (.251-.375) x 0.550	5000
183009	Steel / Steel Zinc CR+3	6-8 3/16 (.376-.500) x 0.675	4000
183010	Steel / Steel Zinc CR+3	6-10 3/16 (.501-.625) x 0.800	4000
183011	Steel / Steel Zinc CR+3	6-12 3/16 (.626-.750) x 0.925	4000
183012	Steel / Steel Zinc CR+3	8-2 1/4 (.031-.125) x 0.350	2000
183013	Steel / Steel Zinc CR+3	8-4 1/4 (.126-.250) x 0.475	2000
183014	Steel / Steel Zinc CR+3	8-6 1/4 (.251-.375) x 0.600	2000
183015	Steel / Steel Zinc CR+3	8-8 1/4 (.376-.500) x 0.725	2000

Most commonly used Rivet in the industry. Low cost and versatile solution for applications where back side of a job cannot be accessed.



- IFI-114, Style 1, Grade 30
- Body Diameters: 3/32" thru 1/4"
- Grip Range: 0.031" thru 1"

METAL TO METAL - For Holding Two Or More Pieces Of Material Together Typically In Sheet Metal Applications.

DOME HEAD BLIND RIVET



- IFI-114, Style 1, Grade 30
- Body Diameters: 3/32" thru 1/4"
- Grip Range: 0.031" thru 1"

Part No.	Item Description	Size	Bulk Qty.
183016	Steel / Steel Zinc CR+3	8-10 1/4 (.501-.625) x 0.850	2000
183017	Steel / Steel Zinc CR+3	8-12 1/4 (.626-.750) x 0.975	2000
183027	Steel / Steel Zinc CR+3	6-14 3/16 (.751-.875) x 1.050	3000
183028	Steel / Steel Zinc CR+3	6-16 3/16 (.876-1.000) x 1.175	3000
183029	Steel / Steel Zinc CR+3	3-2 3/32 (.031-.125) x 0.225	10000
183030	Steel / Steel Zinc CR+3	3-4 3/32 (.126-.250) x 0.335	10000
183031	Steel / Steel Zinc CR+3	3-6 3/32 (.251-.375) x 0.475	10000
183032	Steel / Steel Zinc CR+3	4-1 1/8 (.031-.062) x 0.188	10000
183033	Steel / Steel Zinc CR+3	4-5 1/8 (.251-.312) x 0.438	10000
183034	Steel / Steel Zinc CR+3	4-10 1/8 (.501-.625) x 0.750	8000
183035	Steel / Steel Zinc CR+3	5-2 5/32 (.031-.125) x 0.275	8000
183036	Steel / Steel Zinc CR+3	5-3 5/32 (.126-.187) x 0.338	8000
183037	Steel / Steel Zinc CR+3	5-4 5/32 (.188-.250) x 0.400	8000
183038	Steel / Steel Zinc CR+3	5-6 5/32 (.251-.375) x 0.525	6000
183039	Steel / Steel Zinc CR+3	5-8 5/32 (.376-.500) x 0.650	6000
183040	Steel / Steel Zinc CR+3	5-10 5/32 (.501-.625) x 0.800	6000
183041	Steel / Steel Zinc CR+3	5-12 5/32 (.626-.750) x 0.925	5000
183042	Steel / Steel Zinc CR+3	6-3 3/16 (.126-.187) x 0.387	5000
183043	Steel / Steel Zinc CR+3	6-18 3/16 (1.001-1.125) x 1.3	2000
183044	Steel / Steel Zinc CR+3	8-14 1/4 (.751-.875) x 1.1	1500
183045	Steel / Steel Zinc CR+3	8-16 1/4 (.876-1.000) x 1.225	1500
183046	Steel / Steel Zinc CR+3	4-2 1/8 (.063-.125) x 0.250 white painted	10000
183047	Steel / Steel Zinc CR+3	4-2 1/8 (.063-.125) x 0.250 black painted	10000
183048	Steel / Steel Zinc CR+3	4-3 1/8 (.126-.187) x 0.313 white painted	10000
183049	Steel / Steel Zinc CR+3	4-3 1/8 (.126-.187) x 0.313 black painted	10000
183050	Steel / Steel Zinc CR+3	4-4 1/8 (.188-.250) x 0.375 white painted	10000
183051	Steel / Steel Zinc CR+3	4-4 1/8 (.188-.250) x 0.375 black painted	10000

Most commonly used Rivet in the industry. Low cost and versatile solution for applications where back side of a job cannot be accessed.

METAL TO METAL - For Holding Two Or More Pieces Of Material Together Typically In Sheet Metal Applications.

DOME HEAD BLIND RIVET



- IFI-114, Style 1, Grade 11
- Body Diameters: 3/32" thru 1/4"
- Grip Range: 0.031" thru 1.250"

Part No.	Item Description	Size	Bulk Qty.
184001	Aluminum / Aluminum	4-2 1/8 (.063-.125) x 0.250	10000
184002	Aluminum / Aluminum	4-3 1/8 (.126-.187) x 0.313	10000
184003	Aluminum / Aluminum	4-4 1/8 (.188-.250) x 0.375	10000
184004	Aluminum / Aluminum	4-6 1/8 (.313-.375) x 0.500	10000
184005	Aluminum / Aluminum	4-8 1/8 (.376-.500) x 0.625	10000
184006	Aluminum / Aluminum	6-2 3/16 (.031-.125) x 0.300	5000
184007	Aluminum / Aluminum	6-4 3/16 (.188-.250) x 0.425	5000

Most commonly used Rivet in the industry. Low cost and versatile solution for applications where back side of a job cannot be accessed.

METAL TO METAL - For Holding Two Or More Pieces Of Material Together Typically In Sheet Metal Applications.

DOME HEAD BLIND RIVET

Part No.	Item Description	Size	Bulk Qty.
184008	Aluminum / Aluminum	6-6 3/16 (.251-.375) x 0.550	5000
184009	Aluminum / Aluminum	6-8 3/16 (.376-.500) x 0.675	4000
184010	Aluminum / Aluminum	6-10 3/16 (.501-.625) x 0.800	4000
184011	Aluminum / Aluminum	6-12 3/16 (.626-.750) x 0.925	4000
184012	Aluminum / Aluminum	8-2 1/4 (.031-.125) x 0.350	2000
184013	Aluminum / Aluminum	8-4 1/4 (.126-.250) x 0.475	2000
184014	Aluminum / Aluminum	8-6 1/4 (.251-.375) x 0.600	2000
184015	Aluminum / Aluminum	8-8 1/4 (.376-.500) x 0.725	2000
184016	Aluminum / Aluminum	8-10 1/4 (.501-.625) x 0.850	2000
184017	Aluminum / Aluminum	8-12 1/4 (.626-.750) x 0.975	2000
184030	Aluminum / Aluminum	3-2 3/32 (.031-.125) x 0.225	10000
184031	Aluminum / Aluminum	3-4 3/32 (.126-.250) x 0.335	10000
184032	Aluminum / Aluminum	3-6 3/32 (.251-.375) x 0.475	10000
184033	Aluminum / Aluminum	4-1 1/8 (.031-.062) x 0.188	10000
184034	Aluminum / Aluminum	4-5 1/8 (.251-.312) x 0.438	10000
184035	Aluminum / Aluminum	4-10 1/8 (.501-.625) x 0.750	8000
184036	Aluminum / Aluminum	5-2 5/32 (.031-.125) x 0.275	8000
184037	Aluminum / Aluminum	5-3 5/32 (.126-.187) x 0.338	8000
184038	Aluminum / Aluminum	5-4 5/32 (.188-.250) x 0.400	8000
184039	Aluminum / Aluminum	5-6 5/32 (.251-.375) x 0.525	6000
184040	Aluminum / Aluminum	5-8 5/32 (.376-.500) x 0.650	6000
184041	Aluminum / Aluminum	5-10 5/32 (.501-.625) x 0.800	6000
184042	Aluminum / Aluminum	5-12 5/32 (.626-.750) x 0.925	5000
184043	Aluminum / Aluminum	6-3 3/16 (.126-.187) x 0.362	5000
184044	Aluminum / Aluminum	6-14 3/16 (.751-.875) x 1.050	3000
184045	Aluminum / Aluminum	6-16 3/16 (.876-1.000) x 1.175	3000
184046	Aluminum / Aluminum	6-18 3/16 (1.001-1.125) x 1.3	2000
184047	Aluminum / Aluminum	6-20 3/16 (1.126-1.250) x 1.5	2000
184048	Aluminum / Aluminum	8-14 1/4 (.751-.875) x 1.1	1500
184049	Aluminum / Aluminum	8-16 1/4 (.876-1.000) x 1.225	1500
184050	Aluminum / Aluminum	4-2 1/8 (.063-.125) x 0.250, white painted	10000
184051	Aluminum / Aluminum	4-2 1/8 (.063-.125) x 0.250, black painted	10000
184052	Aluminum / Aluminum	4-3 1/8 (.126-.187) x 0.313, white painted	10000
184053	Aluminum / Aluminum	4-3 1/8 (.126-.187) x 0.313, black painted	10000
184054	Aluminum / Aluminum	4-4 1/8 (.188-.250) x 0.375, white painted	10000
184055	Aluminum / Aluminum	4-4 1/8 (.188-.250) x 0.375, black painted	10000
184056	Aluminum / Aluminum	4-2 1/8 (.063-.125) x 0.250, bronze painted	20000
184057	Aluminum / Aluminum	4-3 1/8 (.126-.187) x 0.313, bronze painted	18000
184058	Aluminum / Aluminum	4-4 1/8 (.188-.250) x 0.375, bronze painted	10000

Most commonly used Rivet in the industry. Low cost and versatile solution for applications where back side of a job cannot be accessed.



- IFI-114, Style 1, Grade 11
- Body Diameters: 3/32" thru 1/4"
- Grip Range: 0.031" thru 1.250"

METAL TO METAL - For Holding Two Or More Pieces Of Material Together Typically In Sheet Metal Applications.

DOME HEAD BLIND RIVET

Part No.	Item Description	Size	Bulk Qty.
185001	AL5056 / Steel	4-2 1/8 (.063-.125) x 0.250	10000
185002	AL5056 / Steel	4-3 1/8 (.126-.187) x 0.313	10000
185003	AL5056 / Steel	4-4 1/8 (.188-.250) x 0.375	10000
185004	AL5056 / Steel	4-6 1/8 (.313-.375) x 0.500	10000
185005	AL5056 / Steel	4-8 1/8 (.376-.500) x 0.625	10000
185006	AL5056 / Steel	6-2 3/16 (.031-.125) x 0.300	5000
185007	AL5056 / Steel	6-4 3/16 (.188-.250) x 0.425	5000
185008	AL5056 / Steel	6-6 3/16 (.251-.375) x 0.550	5000
185009	AL5056 / Steel	6-8 3/16 (.376-.500) x 0.675	4000
185010	AL5056 / Steel	6-10 3/16 (.501-.625) x 0.800	4000
185011	AL5056 / Steel	6-12 3/16 (.626-.750) x 0.925	4000
185012	AL5056 / Steel	8-2 1/4 (.031-.125) x 0.350	2000
185013	AL5056 / Steel	8-4 1/4 (.126-.250) x 0.475	2000
185014	AL5056 / Steel	8-6 1/4 (.251-.375) x 0.600	2000
185015	AL5056 / Steel	8-8 1/4 (.376-.500) x 0.725	2000
185016	AL5056 / Steel	8-10 1/4 (.501-.625) x 0.850	2000
185017	AL5056 / Steel	8-12 1/4 (.626-.750) x 0.975	2000
185032	AL5056 / Steel	3-2 3/32 (.031-.125) x 0.225	10000
185033	AL5056 / Steel	3-4 3/32 (.126-.250) x 0.335	10000
185034	AL5056 / Steel	3-6 3/32 (.251-.375) x 0.475	10000
185035	AL5056 / Steel	4-1 1/8 (.031-.062) x 0.188	10000
185036	AL5056 / Steel	4-5 1/8 (.251-.312) x 0.438	10000
185037	AL5056 / Steel	4-10 1/8 (.501-.625) x 0.750	8000
185038	AL5056 / Steel	5-2 5/32 (.031-.125) x 0.275	8000
185039	AL5056 / Steel	5-3 5/32 (.126-.187) x 0.338	8000
185040	AL5056 / Steel	5-4 5/32 (.188-.250) x 0.400	8000
185041	AL5056 / Steel	5-6 5/32 (.251-.375) x 0.525	6000
185042	AL5056 / Steel	5-8 5/32 (.376-.500) x 0.650	6000
185043	AL5056 / Steel	5-10 5/32 (.501-.625) x 0.800	6000
185044	AL5056 / Steel	5-12 5/32 (.626-.750) x 0.925	5000
185045	AL5056 / Steel	6-3 3/16 (.126-.187) x 0.362	5000
185046	AL5056 / Steel	6-14 3/16 (.751-.875) x 1.050	3000
185047	AL5056 / Steel	6-16 3/16 (.876-1.000) x 1.175	3000
185048	AL5056 / Steel	6-18 3/16 (1.001-1.125) x 1.3	2000
185049	AL5056 / Steel	6-20 3/16 (1.126-1.250) x 1.425	2000
185050	AL5056 / Steel	6-22 3/16 (1.251-1.375) x 1.55	2000
185051	AL5056 / Steel	8-14 1/4 (.751-.875) x 1.1	1500
185052	AL5056 / Steel	8-16 1/4 (.876-1.000) x 1.225	1500



- IFI-114, Style 1, Grade 19
- Body Diameters: 3/32" thru 1/4"
- Grip Range: 0.031" thru 1.250"

Most commonly used Rivet in the industry. Low cost and versatile solution for applications where back side of a job cannot be accessed.

METAL TO METAL - For Holding Two Or More Pieces Of Material Together Typically In Sheet Metal Applications.

DOME HEAD BLIND RIVET

Part No.	Item Description	Size	Bulk Qty.
186001	Stainless 304 / Stainless 304	4-2 1/8 (.063-.125) x 0.250	10000
186002	Stainless 304 / Stainless 304	4-3 1/8 (.126-.187) x 0.313	10000
186003	Stainless 304 / Stainless 304	4-4 1/8 (.188-.250) x 0.375	10000
186004	Stainless 304 / Stainless 304	4-6 1/8 (.313-.375) x 0.500	10000
186005	Stainless 304 / Stainless 304	4-8 1/8 (.376-.500) x 0.625	10000
186006	Stainless 304 / Stainless 304	6-2 3/16 (.031-.125) x 0.300	5000
186007	Stainless 304 / Stainless 304	6-4 3/16 (.188-.250) x 0.425	5000
186008	Stainless 304 / Stainless 304	6-6 3/16 (.251-.375) x 0.550	5000
186009	Stainless 304 / Stainless 304	6-8 3/16 (.376-.500) x 0.675	4000
186010	Stainless 304 / Stainless 304	6-10 3/16 (.501-.625) x 0.800	4000
186011	Stainless 304 / Stainless 304	6-12 3/16 (.626-.750) x 0.925	4000
186012	Stainless 304 / Stainless 304	8-2 1/4 (.031-.125) x 0.350	2000
186013	Stainless 304 / Stainless 304	8-4 1/4 (.126-.250) x 0.475	2000
186014	Stainless 304 / Stainless 304	8-6 1/4 (.251-.375) x 0.600	2000
186015	Stainless 304 / Stainless 304	8-8 1/4 (.376-.500) x 0.725	2000
186016	Stainless 304 / Stainless 304	8-10 1/4 (.501-.625) x 0.850	2000
186017	Stainless 304 / Stainless 304	8-12 1/4 (.626-.750) x 0.975	2000
186024	Stainless 304 / Stainless 304	4-1 1/8 (.031-.062) x 0.188	10000
186025	Stainless 304 / Stainless 304	4-5 1/8 (.251-.312) x 0.438	10000
186026	Stainless 304 / Stainless 304	5-2 5/32 (.031-.125) x 0.275	8000
186027	Stainless 304 / Stainless 304	5-3 5/32 (.126-.187) x 0.338	8000
186028	Stainless 304 / Stainless 304	5-4 5/32 (.188-.250) x 0.400	8000
186029	Stainless 304 / Stainless 304	5-6 5/32 (.251-.375) x 0.525	6000
186030	Stainless 304 / Stainless 304	5-8 5/32 (.376-.500) x 0.650	6000
186031	Stainless 304 / Stainless 304	5-10 5/32 (.501-.625) x 0.800	6000
186032	Stainless 304 / Stainless 304	6-3 3/16 (.126-.187) x 0.362	5000
VR1042	Stainless 304 / Steel	4-2 1/8 (0.063-0.125) x 0.250	6000
VR1044	Stainless 304 / Steel	4-4 1/8 (0.188-0.250) x 0.375	6000
VR1054	Stainless 304 / Steel	5-4 5/32 (0.188-0.250) x 0.400	3000
VR1064	Stainless 304 / Steel	6-4 3/16 (0.188-0.250) x 0.425	2000
VR1066	Stainless 304 / Steel	6-6 3/16 (0.251-0.375) x 0.550	1600
VR1086	Stainless 304 / Steel	8-6 1/4 (0.251-0.375) x 0.600	1000

Most commonly used Rivet in the industry. Low cost and versatile solution for applications where back side of a job cannot be accessed.



- IFI-114, Style 1, Grade 51
- Body Diameters: 1/8" thru 1/4"
- Grip Range: 0.031" thru 0.750"

METAL TO METAL - For Holding Two Or More Pieces Of Material Together Typically In Sheet Metal Applications.

DOME CLOSE-END BLIND RIVET



- IFI-126, Grade 19
- Body Diameters: 1/8" thru 1/4"
- Grip Range: 0.020" thru 0.625"

Part No.	Item Description	Size	Bulk Qty.
W30001	Aluminum/Steel ASCE	4-1 1/8 (.020-.062)	10000
W30002	Aluminum/Steel ASCE	4-2 1/8 (.063-.125)	10000
W30003	Aluminum/Steel ASCE	4-3 1/8 (.126-.187)	10000
W30004	Aluminum/Steel ASCE	4-4 1/8 (.188-.250)	10000
W30005	Aluminum/Steel ASCE	4-5 1/8 (.251-.312)	10000
W30006	Aluminum/Steel ASCE	4-6 1/8 (.313-.375)	10000
W30007	Aluminum/Steel ASCE	4-8 1/8 (.376-.500)	8000
W30008	Aluminum/Steel ASCE	5-2 5/32 (.020-.125)	8000
W30009	Aluminum/Steel ASCE	5-3 5/32 (.126-.187)	8000
W30010	Aluminum/Steel ASCE	5-4 5/32 (.188-.250)	8000
W30011	Aluminum/Steel ASCE	6-2 3/16 (.020-.125)	5000
W30012	Aluminum/Steel ASCE	6-4 3/16 (.126-.250)	5000
W30013	Aluminum/Steel ASCE	6-6 3/16 (.251-.375)	4000
W30014	Aluminum/Steel ASCE	6-8 3/16 (.376-.500)	4000
W30015	Aluminum/Steel ASCE	6-10 3/16 (.501-.625)	4000
W30016	Aluminum/Steel ASCE	8-4 1/4 (.062-.250)	2000
W30017	Aluminum/Steel ASCE	8-6 1/4 (.251-.375)	2000

Excellent choice where moisture resistance or positive containment is required.

METAL TO METAL - For Holding Two Or More Pieces Of Material Together Typically In Sheet Metal Applications.

COUNTERSUNK CLOSE-END BLIND RIVET



- IFI-126 Grade 19
- Body Diameters: 1/8" thru 3/16"
- Grip Range: 0.020" thru 0.375"

Part No.	Item Description	Size	Bulk Qty.
W31001	Aluminum/Steel ASCCE	4-1 1/8 (.020-.062)	10000
W31002	Aluminum/Steel ASCCE	4-2 1/8 (.063-.125)	10000
W31003	Aluminum/Steel ASCCE	4-3 1/8 (.126-.187)	10000
W31004	Aluminum/Steel ASCCE	4-4 1/8 (.188-.250)	10000
W31005	Aluminum/Steel ASCCE	4-5 1/8 (.251-.312)	10000
W31006	Aluminum/Steel ASCCE	5-3 5/32 (.126-.187)	8000
W31007	Aluminum/Steel ASCCE	6-4 3/16 (.188-.250)	5000
W31008	Aluminum/Steel ASCCE	6-6 3/16 (.251-.375)	4000

Excellent choice where moisture resistance or positive containment is required.

METAL TO METAL - For Holding Two Or More Pieces Of Material Together Typically In Sheet Metal Applications.

DOME CLOSE-END BLIND RIVET



- IFI-126 Grade 15
- Body Diameters: 1/8" thru 3/16"
- Grip Range: 0.020" thru 0.625"

Part No.	Item Description	Size	Bulk Qty.
W32001	Aluminum/Aluminum AACE	4-1 1/8 (.020-.062)	10000
W32002	Aluminum/Aluminum AACE	4-2 1/8 (.063-.125)	10000
W32003	Aluminum/Aluminum AACE	4-3 1/8 (.126-.187)	10000
W32004	Aluminum/Aluminum AACE	4-4 1/8 (.188-.250)	10000
W32005	Aluminum/Aluminum AACE	4-6 1/8 (.251-.375)	10000
W32006	Aluminum/Aluminum AACE	5-2 5/32 (.020-.125)	8000
W32007	Aluminum/Aluminum AACE	5-3 5/32 (.126-.187)	8000
W32008	Aluminum/Aluminum AACE	5-4 5/32 (.188-.250)	8000
W32009	Aluminum/Aluminum AACE	6-2 3/16 (.020-.125)	5000
W32010	Aluminum/Aluminum AACE	6-4 3/16 (.126-.250)	5000
W32011	Aluminum/Aluminum AACE	6-6 3/16 (.251-.375)	4000
W32012	Aluminum/Aluminum AACE	6-8 3/16 (.376-.500)	4000
W32013	Aluminum/Aluminum AACE	6-10 3/16 (.501-.625)	4000

Excellent choice where moisture resistance or positive containment is required.

METAL TO METAL - For Holding Two Or More Pieces Of Material Together Typically In Sheet Metal Applications.

DOME CLOSE-END BLIND RIVET



- IFI-126
- Body Diameters: 1/8" thru 3/16"
- Grip Range: 0.020" thru 0.625"

Part No.	Item Description	Size	Bulk Qty.
W33001	Stainless 304 / Stainless 420 Grooved STSSCE	4-2 1/8 (.020-.125)	10000
W33002	Stainless 304 / Stainless 420 Grooved STSSCE	4-3 1/8 (.126-.187)	10000
W33003	Stainless 304 / Stainless 420 Grooved STSSCE	4-4 1/8 (.188-.250)	10000
W33004	Stainless 304 / Stainless 420 Grooved STSSCE	5-3 5/32 (.126-.187)	8000
W33005	Stainless 304 / Stainless 420 Grooved STSSCE	6-2 3/16 (.020-.125)	5000
W33006	Stainless 304 / Stainless 420 Grooved STSSCE	6-4 3/16 (.126-.250)	5000
W33007	Stainless 304 / Stainless 420 Grooved STSSCE	6-6 3/16 (.251-.375)	4000
W33008	Stainless 304 / Stainless 420 Grooved STSSCE	6-8 3/16 (.376-.500)	4000
W33009	Stainless 304 / Stainless 420 Grooved STSSCE	6-10 3/16 (.501-.625)	4000

Excellent choice where moisture resistance or positive containment is required.

METAL TO METAL - For Holding Two Or More Pieces Of Material Together Typically In Sheet Metal Applications.

DOME MULTI-GRIP TYPE BLIND RIVET

Part No.	Item Description	Size	Bulk Qty.
W34001	Steel/Steel Zinc SSMG	41-42 1/8 (.039-.125)	10000
W34002	Steel/Steel Zinc SSMG	52-53 5/32 (.063-.187)	8000
W34003	Steel/Steel Zinc SSMG	62-63 3/16 (.063-.187)	5000
W34004	Steel/Steel Zinc SSMG	62-64 3/16 (.063-.250)	5000
W35001	Aluminum/Steel Zinc ASMG	41-43 1/8 (.039-.187)	10000
W35002	Aluminum/Steel Zinc ASMG	42-44 1/8 (.062-.250)	10000
W35003	Aluminum/Steel Zinc ASMG	43-45 1/8 (.125-.312)	10000
W35004	Aluminum/Steel Zinc ASMG	44-46 1/8 (.188-.375)	10000
W35005	Aluminum/Steel Zinc ASMG	45-47 1/8 (.251-.437)	10000
W35006	Aluminum/Steel Zinc ASMG	52-54 5/32 (.062-.250)	8000
W35007	Aluminum/Steel Zinc ASMG	53-55 5/32 (.125-.312)	8000
W35008	Aluminum/Steel Zinc ASMG	54-56 5/32 (.187-.375)	6000
W35009	Aluminum/Steel Zinc ASMG	56-58 5/32 (.312-.500)	6000
W35010	Aluminum/Steel Zinc ASMG	62-64 3/16 (.063-.250)	5000
W35011	Aluminum/Steel Zinc ASMG	64-66 3/16 (.188-.375)	4000
W35012	Aluminum/Steel Zinc ASMG	65-67 3/16 (.251-.437)	4000
W35013	Aluminum/Steel Zinc ASMG	66-68 3/16 (.313-.500)	4000
W35014	Aluminum/Steel Zinc ASMG	610-612 3/16 (.563-.750)	3000



- IFI-116 Grade 30
- IFI-116 Grade 19
- Body Diameters: 1/8" thru 3/16"
- Grip Range: 0.039" thru 0.750"

Ideal for reducing rivet inventory and cost by taking the place of two or more sizes of standard rivets. Multi-grip blind rivets are specially designed for applications where materials of different thickness would generally require rivets in multiple sizes. Tip of the mandrel locks itself in the rivet eliminating the risk of the mandrel vibrating loose.

METAL TO METAL - For Holding Two Or More Pieces Of Material Together Typically In Sheet Metal Applications.

LARGE FLANGE MULTI-GRIP TYPE BLIND RIVET

Part No.	Item Description	Size	Bulk Qty.
W36001	Aluminum/Steel Zinc	41-43 1/8 (.063-.187)	10000
W36002	Aluminum/Steel Zinc	42-44 1/8 (.062-.250)	10000
W36003	Aluminum/Steel Zinc	43-45 1/8 (.125-.312)	8000
W36004	Aluminum/Steel Zinc	52-54 5/32 (.062-.250)	5000
W36005	Aluminum/Steel Zinc	53-55 5/32 (.125-.312)	5000
W36006	Aluminum/Steel Zinc	56-58 5/32 (.312-.500)	5000
W36007	Aluminum/Steel Zinc	62-64 3/16 (.063-.250)	3000
W36008	Aluminum/Steel Zinc	64-66 3/16 (.188-.375)	3000
W36009	Aluminum/Steel Zinc	66-68 3/16 (.313-.500)	2500
W36010	Aluminum/Steel Zinc	610-612 3/16 (.563-.750)	2000



- IFI-116 Grade 19
- Body Diameters: 1/8" thru 3/16"
- Grip Range: 0.062" thru 0.750"

Ideal for reducing rivet inventory and cost by taking the place of two or more sizes of standard rivets. Multi-grip blind rivets are specially designed for applications where materials of different thickness would generally require rivets in multiple sizes. Tip of the mandrel locks itself in the rivet eliminating the risk of the mandrel vibrating loose.

METAL TO METAL - For Holding Two Or More Pieces Of Material Together Typically In Sheet Metal Applications.

COUNTERSUNK MULTI-GRIP TYPE BLIND RIVET

Part No.	Item Description	Size	Bulk Qty.
W37001	Aluminum/Steel Zinc	42-44 1/8 (.062-.250)	10000
W37002	Aluminum/Steel Zinc	43-45 1/8 (.125-.312)	10000
W37003	Aluminum/Steel Zinc	53-55 5/32 (.125-.312)	8000
W37004	Aluminum/Steel Zinc	54-56 5/32 (.187-.375)	5000
W37005	Aluminum/Steel Zinc	63-65 3/16 (.125-.312)	5000
W37006	Aluminum/Steel Zinc	66-68 3/16 (.313-.500)	3000



- IFI-116 Grade 19
- Body Diameters: 1/8" thru 3/16"
- Grip Range: 0.062" thru 0.500"

Ideal for reducing rivet inventory and cost by taking the place of two or more sizes of standard rivets. Multi-grip blind rivets are specially designed for applications where materials of different thickness would generally require rivets in multiple sizes. Tip of the mandrel locks itself in the rivet eliminating the risk of the mandrel vibrating loose.

METAL TO METAL - For Holding Two Or More Pieces Of Material Together Typically In Sheet Metal Applications.

CUP-LOCK RIVET

Part No.	Item Description	Size	Bulk Qty.
VR2001	Aluminum	3/16" x 1/4" (.062-.270)	6000
VR2002	Aluminum	3/16" x 7/16" (.214-.437)	4000
VR2003	Aluminum	1/4" x 3/8" (.080-.375)	2400
VR2004	Aluminum	1/4" x 5/8" (.350-.625)	2000
VR3101	Stainless	3/16" x 1/4" (.062-.270)	2000
VR3102	Stainless	1/4" x 3/8" (.080-.375)	1000
VR4201	Steel	3/16" x 1/4" (.062-.270)	2000
VR4202	Steel	3/16" x 7/16" (.214-.437)	1600
VR4203	Steel	1/4" x 3/8" (.080-.375)	1000
VR4204	Steel	1/4" x 5/8" (.350-.625)	800



- Body Diameters: 3/16" & 1/4"
- Grip Range: 0.062" thru 0.625"

Ideal for reducing rivet inventory and cost by taking the place of two or more sizes of standard rivets. Multi-grip blind rivets are specially designed for applications where materials of different thickness would generally require rivets in multiple sizes. Tip of the mandrel locks itself in the rivet eliminating the risk of the mandrel vibrating loose.

METAL TO METAL - For Holding Two Or More Pieces Of Material Together Typically In Sheet Metal Applications.

BACKUP RIVET WASHER



- Body Diameters: 1/8" thru 1/4"
- Grip Range: 0.056" thru 0.062"

Part No.	Item Description	Size	Bulk Qty.
142001	Aluminum	0.125 x 0.375 x 0.059	10000
142002	Aluminum	0.156 x 0.437 x 0.059	10000
142003	Aluminum	0.187 x 0.500 x 0.059	10000
142004	Aluminum	0.250 x 0.500 x 0.059	10000

Used when installing into softer material and starting the rivet expansion is needed, when a wider clamping surface is desired, or when installing into irregular holes.

CONCRETE / MASONRY - For Pre-Drilling Concrete, Block, Brick, Masonry, And Stone

SDS-PLUS CARBIDE BITS	Part No.	Item Description	Size	Pkg. Qty.
	C10009	SDS-Plus Carbide Bit, 5/32" x 4-1/4" (2" Usable Length)	5/32"x 4 1/4"	1
	■ C10010	SDS-Plus Carbide Bit, 5/32" x 6-1/4" (4" Usable Length)	5/32"x 6 1/4"	1
	■ C10020	SDS-Plus Carbide Bit, 3/16" x 4-1/2" (2" Usable Length)	3/16"x 4 1/2"	1
	■ C10030	SDS-Plus Carbide Bit, 3/16" x 6-1/2" (4" Usable Length)	3/16"x 6 1/2"	1
	■ C10031	SDS-Plus Carbide Bit, 3/16" x 8-1/2" (6" Usable Length)	3/16"x 8 1/2"	1
	C10032	SDS-Plus Carbide Bit, 3/16" x 12-1/2" (10" Usable Length)	3/16"x 12 1/2"	1
	C10033	SDS-Plus Carbide Bit, 7/32" x 6-1/2" (4" Usable Length)	7/32"x 6 1/2"	1
	C10034	SDS-Plus Carbide Bit, 7/32" x 8-1/2" (6" Usable Length)	7/32"x 8 1/2"	1
	C10035	SDS-Plus Carbide Bit, 7/32" x 10-1/2" (8" Usable Length)	7/32"x 10 1/2"	1
	C10036	SDS-Plus Carbide Bit, 7/32" x 16" (14" Usable Length)	7/32"x 16"	1
	■ C10040	SDS-Plus Carbide Bit, 1/4" x 4-1/2" (2" Usable Length)	1/4"x 4 1/2"	1
	■ C10050	SDS-Plus Carbide Bit, 1/4" x 6-1/2" (4" Usable Length)	1/4"x 6 1/2"	1
	■ C10051	SDS-Plus Carbide Bit, 1/4" x 8-1/2" (6" Usable Length)	1/4"x 8 1/2"	1
	C10052	SDS-Plus Carbide Bit, 1/4" x 10-1/2" (8" Usable Length)	1/4"x 10 1/2"	1
	C10053	SDS-Plus Carbide Bit, 1/4" x 14" (12" Usable Length)	1/4"x 14"	1
	C10054	SDS-Plus Carbide Bit, 1/4" x 16" (14" Usable Length)	1/4"x 16"	1
	■ C10060	SDS-Plus Carbide Bit, 5/16" x 6-1/2" (4" Usable Length)	5/16"x 6 1/2"	1
	C10070	SDS-Plus Carbide Bit, 5/16" x 12-1/2" (10" Usable Length)	5/16"x 12 1/2"	1
	■ C10080	SDS-Plus Carbide Bit, 3/8" x 6-1/2" (4" Usable Length)	3/8"x 6 1/2"	1
	C10090	SDS-Plus Carbide Bit, 3/8" x 10-1/2" (8" Usable Length)	3/8"x 10 1/2"	1
● C10100	SDS-Plus Carbide Bit, 3/8" x 12-1/2" (10" Usable Length)	3/8"x 12 1/2"	1	
C10101	SDS-Plus Carbide Bit, 3/8" x 18" (16" Usable Length)	3/8"x 18"	1	
C10102	SDS-Plus Carbide Bit, 3/8" x 24" (22" Usable Length)	3/8"x 24"	1	
C10110	SDS-Plus Carbide Bit, 7/16" x 6-1/2" (4" Usable Length)	7/16"x 6 1/2"	1	
C10111	SDS-Plus Carbide Bit, 7/16" x 12-1/2" (10" Usable Length)	7/16"x 12 1/2"	1	
■ C10120	SDS-Plus Carbide Bit, 1/2" x 6-1/2" (4" Usable Length)	1/2"x 6 1/2"	1	

- Rotary Hammer Drill
- Serrated Head Geometry
- Self Centering Chisel Point
- ANSI B212.15 Specification
- Tungsten Carbide Tip
- Copper/Silver Brazing
- Fastest Dust Removal
- Less Vibration
- Industrial Quality

- Available in bulk pack (25 pcs)
- Available in bulk pack (10 pcs)

Safety First – Always follow manufacturer's instructions and wear impact resistant safety goggles/shield & gloves.

CONCRETE / MASONRY - For Pre-Drilling Concrete, Block, Brick, Masonry, And Stone

SDS-PLUS CARBIDE BITS	Part No.	Item Description	Size	Pkg. Qty.
	C10130	SDS-Plus Carbide Bit, 1/2" x 10-1/2" (8" Usable Length)	1/2"x 10 1/2"	1
	• C10140	SDS-Plus Carbide Bit, 1/2" x 12-1/2" (10" Usable Length)	1/2"x 12 1/2"	1
	C10141	SDS-Plus Carbide Bit, 1/2" x 18" (16" Usable Length)	1/2"x 18"	1
	C10142	SDS-Plus Carbide Bit, 1/2" x 24" (22" Usable Length)	1/2"x 24"	1
	C10150	SDS-Plus Carbide Bit, 9/16" x 6-1/2" (4" Usable Length)	9/16"x 6 1/2"	1
	C10160	SDS-Plus Carbide Bit, 9/16" x 12-1/4" (10" Usable Length)	9/16"x 12 1/4"	1
	C10170	SDS-Plus Carbide Bit, 5/8" x 6-1/4" (4" Usable Length)	5/8"x 6 1/4"	1
	• C10171	SDS-Plus Carbide Bit, 5/8" x 8-1/4" (6" Usable Length)	5/8"x 8 1/4"	1
	C10180	SDS-Plus Carbide Bit, 5/8" x 9-1/2" (7" Usable Length)	5/8"x 9 1/2"	1
	C10190	SDS-Plus Carbide Bit, 5/8" x 12-1/4" (10" Usable Length)	5/8"x 12 1/4"	1
	C10191	SDS-Plus Carbide Bit, 5/8" x 18" (16" Usable Length)	5/8"x 18"	1
	C10192	SDS-Plus Carbide Bit, 5/8" x 24" (22" Usable Length)	5/8"x 24"	1
	• C10193	SDS-Plus Carbide Bit, 3/4" x 8" (6" Usable Length)	3/4"x 8"	1
	C10200	SDS-Plus Carbide Bit, 11/16" x 7" (5" Usable Length)	11/16"x 7"	1
	C10210	SDS-Plus Carbide Bit, 3/4" x 10" (8" Usable Length)	3/4"x 10"	1
	C10220	SDS-Plus Carbide Bit, 3/4" x 12" (10" Usable Length)	3/4"x 12"	1
	C10221	SDS-Plus Carbide Bit, 3/4" x 18" (16" Usable Length)	3/4"x 18"	1
	C10222	SDS-Plus Carbide Bit, 3/4" x 24" (22" Usable Length)	3/4"x 24"	1
	C10223	SDS-Plus Carbide Bit, 7/8" x 8" (6" Usable Length)	7/8"x 8"	1
	C10230	SDS-Plus Carbide Bit, 7/8" x 10" (8" Usable Length)	7/8"x 10"	1
	C10231	SDS-Plus Carbide Bit, 7/8" x 12" (10" Usable Length)	7/8"x 12"	1
C10240	SDS-Plus Carbide Bit, 1" x 10" (8" Usable Length)	1"x 10"	1	
C10241	SDS-Plus Carbide Bit, 1" x 18" (16" Usable Length)	1"x 18"	1	

- Rotary Hammer Drill
- Serrated Head Geometry
- Self Centering Chisel Point
- ANSI B212.15 Specification
- Tungsten Carbide Tip
- Copper/Silver Brazing
- Fastest Dust Removal
- Less Vibration
- Industrial Quality

- Available in bulk pack (25 pcs)
- Available in bulk pack (10 pcs)

Safety First – Always follow manufacturer's instructions and wear impact resistant safety goggles/shield & gloves.

CONCRETE / MASONRY - For Pre-Drilling Concrete, Block, Brick, Masonry, And Stone

SDS-MAX CARBIDE BITS	Part No.	Item Description	Size	Pkg. Qty.
	C13100	SDS-Max Carbide Bit, 3/8" x 13" (8" Usable Length)	3/8"x 13"	1
	C13102	SDS-Max Carbide Bit, 1/2" x 13" (8" Usable Length)	1/2"x 13"	1
	C13104	SDS-Max Carbide Bit, 1/2" x 21" (15-1/2" Usable Length)	1/2"x 21"	1
	C13106	SDS-Max Carbide Bit, 9/16" x 21" (15-1/2" Usable Length)	9/16"x 21"	1
	C13108	SDS-Max Carbide Bit, 5/8" x 13" (8" Usable Length)	5/8"x 13"	1
	C13110	SDS-Max Carbide Bit, 5/8" x 21" (15-1/2" Usable Length)	5/8"x 21"	1
	C13112	SDS-Max Carbide Bit, 5/8" x 36" (31" Usable Length)	5/8"x 36"	1
	C13114	SDS-Max Carbide Bit, 11/16" x 21" (15-1/2" Usable Length)	11/16"x 21"	1
	C13116	SDS-Max Carbide Bit, 3/4" x 13" (8" Usable Length)	3/4"x 13"	1
	C13118	SDS-Max Carbide Bit, 3/4" x 21" (15-1/2" Usable Length)	3/4"x 21"	1
	C13120	SDS-Max Carbide Bit, 3/4" x 36" (32" Usable Length)	3/4"x 36"	1
	C13122	SDS-Max Carbide Bit, 7/8" x 13" (8" Usable Length)	7/8"x 13"	1
	C13124	SDS-Max Carbide Bit, 7/8" x 21" (17" Usable Length)	7/8"x 21"	1
	C13126	SDS-Max Carbide Bit, (7/8" x 36" (32" Usable Length)	7/8"x 36"	1
	C13128	SDS-Max Carbide Bit, 1" x 13" (8" Usable Length)	1"x 13"	1
	C13130	SDS-Max Carbide Bit, 1" x 21" (17" Usable Length)	1"x 21"	1
	C13132	SDS-Max Carbide Bit, 1" x 36" (32" Usable Length)	1"x 36"	1
	C13134	SDS-Max Carbide Bit, 1-1/8" x 17" (13" Usable Length)	1 1/8"x 17"	1
	C13136	SDS-Max Carbide Bit, 1-1/8" x 21" (17" Usable Length)	1 1/8"x 21"	1
	C13138	SDS-Max Carbide Bit, 1-1/8" x 36" (32" Usable Length)	1 1/8"x 36"	1
C13140	SDS-Max Carbide Bit, 1-1/4" x 13" (11" Usable Length)	1 1/4"x 15"	1	
C13142	SDS-Max Carbide Bit, 1-1/4" x 23" (17" Usable Length)	1 1/4"x 23"	1	
C13143	SDS-Max Carbide Bit, 1-1/4" x 36" (31" Usable Length)	1 1/4"x 36"	1	
C13144	SDS-Max Carbide Bit, 1-3/8" x 23" (17" Usable Length)	1 3/8"x 23"	1	
C13146	SDS-Max Carbide Bit, 1-1/2" x 23" (17" Usable Length)	1 1/2"x 23"	1	
C13148	SDS-Max Carbide Bit, 1-3/4" x 23" (18" Usable Length)	1 3/4"x 23"	1	
C13150	SDS-Max Carbide Bit, 2" x 23" (18" Usable Length)	2"x 23"	1	

- Rotary Hammer Drill
- Serrated Head Geometry
- Self Centering Chisel Point
- ANSI B212.15 Specification
- Tungsten Carbide Tip
- Copper/Silver Brazing
- Fastest Dust Removal
- Less Vibration

Safety First – Always follow manufacturer's instructions and wear impact resistant safety goggles/shield & gloves.

CONCRETE / MASONRY - For Pre-Drilling Prior To Installing Drop-In Anchors

SDS-PLUS CARBIDE BITS



- Rotary Hammer Drill
- Stop-Lip Prevents Over-Drilling
- Drill Exact Depth for Drop-In Anchors
- Less Likely to Hit Rebar
- ANSI B212.15 Specification

Part No.	Item Description	Size	Pkg. Qty.
C12100	SDS-PLUS Bit & Stop, 3/8" x 1-1/16" for 1/4" Drop-In Anchor	3/8 x 1-1/16	1
C12102	SDS-PLUS Bit & Stop, 1/2" x 13/16" for 3/8" S Drop-In Anchor	1/2 x 13/16	1
C12104	SDS-PLUS Bit & Stop, 1/2" x 1-11/16" for 3/8" Drop-In Anchor	1/2 x 1-11/16	1
C12106	SDS-PLUS Bit & Stop, 5/8" x 1-3/16" for 1/2" S Drop-In Anchor	5/8 x 1-3/16	1
C12108	SDS-PLUS Bit & Stop, 5/8" x 2-1/16" for 1/2" Drop-In Anchor	5/8 x 2-1/16	1

Safety First – Always follow manufacturer's instructions and wear impact resistant safety goggles/shield & gloves.

CONCRETE / MASONRY - For Pre-Drilling Prior To Installing Concrete Screws

SDS-HEX CARBIDE BITS



- Special Tungsten Carbide Tip
- Copper/Silver Brazing
- ANSI B212.15 Specification

Part No.	Item Description	Size	Pkg. Qty.
C19200	SDS-HEX Concrete Screw Bit 5/32" x 5" (2-1/2" Usable Length)	5/32"x 5"	1
C19201	SDS-HEX Concrete Screw Bit 5/32 x 7" (4-1/2" Usable Length)	5/32"x 7"	1
C19100	SDS-HEX Concrete Screw Bit 3/16" x 5" (2-1/2" Usable Length)	3/16"x 5"	1
C19101	SDS-HEX Concrete Screw Bit 3/16" x 7" (4-1/2") Usable Length)	3/16"x 7"	1

Safety First – Always follow manufacturer's instructions and wear impact resistant safety goggles/shield & gloves.

METAL / STAINLESS / CONCRETE - USA Manufactured Cutoff Wheels For Angle Grinders And Chopsaws

CUTOFF WHEELS



- **Manufactured in USA**
- **Resin Bonded**
- **Fast Stock Removal**
- **Premium Quality**
- **Long Cutting Life**

Part No.	Item Description	Size	Case Qty.
A01010	(USA) Type 1 Cutoff Wheel -Treated Aluminum Oxide, TA60U	4-1/2" x .045" x 7/8"	25
A01011	(USA) Type 1 Cutoff Wheel - Treated Aluminum Oxide, TA60U	5" x .045" x 7/8"	25
A01012	(USA) Type 1 Cutoff Wheel -Treated Aluminum Oxide, TA60U	6" x .045" x 7/8"	25
A01013	(USA) Type 1 Cutoff Wheel -Treated Aluminum Oxide, TA60U	7" x .045" x 7/8"	25
A01020	(USA) Type 27 Cutoff Wheel - Treated Aluminu, Oxide, TA60U	4-1/2" x .045" x 7/8"	25
A01021	(USA) Type 27 Cutoff Wheel - Treated Aluminu, Oxide, TA60U	5" x .045" x 7/8"	25
A01022	(USA) Type 27 Cutoff Wheel - Treated Aluminu, Oxide, TA60U	6" x .045" x 7/8"	25
A01023	(USA) Type 27 Cutoff Wheel - Treated Aluminu, Oxide, TA60U	7" x .045" x 7/8"	25
A01030	(USA) Type 1 (Chop Saw Wheel) Treated Aluminum Oxide, A46T	14" x 3/32 x 1"	10
A01032	(USA) Type 1 (Chop Saw Wheel) Treated Aluminum Oxide, A36T	14" x 3/32 x 1"	10

Safety First – Always follow manufacturer's instructions and wear impact resistant safety goggles/ shield & gloves.

METAL / STAINLESS / CONCRETE - USA Manufactured Cutoff Wheels For High-Speed Gas Saws

CUTOFF WHEELS



- **Manufactured in USA**
- **Fast Stock Removal**
- **Premium Quality**
- **Long Cutting Life**

Part No.	Item Description	Size	Case Qty.
A02010	(USA) Type 1, Portable Hi-Speed Gas Saw Cutoff Wheel, A24R	14" x 1/8" x 1"	10
A02011	(USA) Type 1, Portable Hi-Speed Gas Saw Cutoff Wheel, A24R	14" x 1/8" x 20MM	10
A02016	(USA) Type 1, Portable Hi-Speed Gas Saw Cutoff Wheel, TA24R	14" x 1/8" x 1"	10
A02017	(USA) Type 1, Portable Hi-Speed Gas Saw Cutoff Wheel, TA24R	14" x 1/8" x 20MM	10
A02022	(USA) Type 1, Portable Hi-Speed Gas Saw Cutoff Wheel, AC24R	14" x 1/8" x 1"	10
A02023	(USA) Type 1, Portable Hi-Speed Gas Saw Cutoff Wheel, AC24R	14" x 1/8" x 20MM	10
A02028	(USA) Type 1, Portable Hi-Speed Gas Saw Cutoff Wheel, C24R	14" x 1/8" x 1"	10
A02029	(USA) Type 1, Portable Hi-Speed Gas Saw Cutoff Wheel, C24R	14" x 1/8" x 20MM	10

C24R (Silicone Carbide Grain) for Cured Concrete, Masonry, Brick, Block, and Stone. Popular choice for masonry work.

A24R (Aluminum Oxide Grain) for Ferrous Metals, Structural Steel, Iron, and Rebar. A consistently performing wheel for a variety of applications

AC24R (Aluminum Oxide and Silicone Carbide Grain) for Ductile Pipe, Cast Iron, Concrete, Coated Steel, Sewer and Water Mains.

TA24R (Specialty Treated Aluminum Oxide Grain Hard Bond) for Thin Metals, Roofing, Decking, and Car Dismantling

Safety First – Always follow manufacturer's instructions and wear impact resistant safety goggles/ shield & gloves.

METAL / STAINLESS - For Use On Steel And Stainless

TYPE 27 GRINDING WHEELS



- Resin Bonded
- Reinforced with Glass Fiber
- For Steel and Stainless
- Good Cutting Life
- Good Removal Rate
- Contaminant Free

Part No.	Item Description	Size	Case Qty.
A05010	Type 27 - Grinding Wheel, Aluminum Oxide, AS24/30 PBF, Arbor	4 1/2" x 1/4" x 7/8"	25
A05012	Type 27 - Grinding Wheel, Aluminum Oxide, AS24/30 PBF, Nut Arbor	4 1/2"x1/4"x5/8-11"	10
A05014	Type 27 - Grinding Wheel, Aluminum Oxide, AS24/30 PBF, Arbor	5" x 1/4" x 7/8"	25
A05016	Type 27 - Grinding Wheel, Aluminum Oxide, AS24/30 PBF, Nut Arbor	5" x 1/4" x 5/8"-11	10
A05018	Type 27 - Grinding Wheel, Aluminum Oxide, AS24/30 PBF, Arbor	6" x 1/4" x 7/8"	25
A05020	Type 27 - Grinding Wheel, Aluminum Oxide, AS24/30 PBF, Nut Arbor	6" x 1/4" x 5/8"-11	10
A05022	Type 27 - Grinding Wheel, Aluminum Oxide, AS24/30 PBF, Arbor	7" x 1/4" x 7/8"	10
A05024	Type 27 - Grinding Wheel, Aluminum Oxide, AS24/30 PBF, Nut Arbor	7" x 1/4" x 5/8"-11	10
A05026	Type 27 - Grinding Wheel, Aluminum Oxide, AS24/30 PBF, Arbor	9" x 1/4" x 7/8"	10
A05128	Type 27 - Grinding Wheel, Aluminum Oxide, AS24/30 PBF, Nut Arbor	9" x 1/4" x 5/8"-11	10

Safety First – Always follow manufacturer's instructions and wear impact resistant safety goggles/ shield & gloves.

METAL / STAINLESS - For All Metals

TYPE 29 FLAP DISCS



- Excellent Cutting Life
- No Burning of Parts
- Silent, Vibration Free Grinding

Part No.	Item Description	Size	Case Qty.
A10010	Type-29 Flap Disc, Zirconia, 40 Grit	4-1/2" x 7/8"	10
A10011	Type-29 Flap Disc, Zirconia, 60 Grit	4-1/2" x 7/8"	10
A10012	Type-29 Flap Disc, Zirconia, 80 Grit	4-1/2" x 7/8"	10
A10015	Type-29 Flap Disc, Zirconia, 40 Grit	5" x 7/8"	10
A10016	Type-29 Flap Disc, Zirconia, 60 Grit	5" x 7/8"	10
A10017	Type-29 Flap Disc, Zirconia, 80 Grit	5" x 7/8"	10
A10100	Type-29 Flap Disc, Zirconia, 40 Grit	4-1/2" x 5/8-11	10
A10101	Type-29 Flap Disc, Zirconia, 60 Grit	4-1/2" x 5/8-11	10
A10102	Type-29 Flap Disc, Zirconia, 80 Grit	4-1/2" x 5/8-11	10
A10105	Type-29 Flap Disc, Zirconia, 40 Grit	5" x 5/8-11	10
A10106	Type-29 Flap Disc, Zirconia, 60 Grit	5" x 5/8-11	10
A10107	Type-29 Flap Disc, Zirconia, 80 Grit	5" x 5/8-11	10

Safety First – Always follow manufacturer's instructions and wear impact resistant safety goggles/ shield & gloves.

METAL / STAINLESS - For All Metals

TYPE 27 FLAP DISCS



- Complete 2 processes with one dual surface disk
- New ceramic hybrid fabric allows grinding of work pieces with just one coarse to medium grit disk

Part No.	Item Description	Size	Case Qty.
A12010	Type-27 Combo Flap Disk, 40/60 Grit	4-1/2" x 5/8-11	10
A12011	Type-27 Combo Flap Disk, 60/80 Grit	4-1/2" x 5/8-11	10
A12012	Type-27 Combo Flap Disk, 80/120 Grit	4-1/2" x 5/8-11	10
A12015	Type-27 Combo Flap Disk, 40/60 Grit	5" x 5/8-11	10
A12016	Type-27 Combo Flap Disk, 60/80 Grit	5" x 5/8-11	10
A12017	Type-27 Combo Flap Disk, 80/120 Grit	5" x 5/8-11	10

Safety First – Always follow manufacturer's instructions and wear impact resistant safety goggles/shield & gloves.

METAL - General Purpose Hand-Pads

HAND PADS



- High mineral content
- Non-woven nylon, easy to fold
- Non-metallic, won't rust
- Long lasting w/high resistance to tearing

Part No.	Item Description	Size	Case Qty.
A20010	Maroon General Purpose Non-woven	6" x 9"	10
A20011	Grey M19 Ultra Fine Non-woven	6" x 9"	10
A20012	Green M11 Fine Non-woven	6" x 9"	10
A20013	White Non Abrasive Non-woven	6" x 9"	10
A20014	Tan Heavy Duty Coarse Non-woven	6" x 9"	10

Safety First – Always follow manufacturer's instructions and wear impact resistant safety goggles/shield & gloves.



GENERAL PURPOSE

HAND TOOLS

Part No.	Item Description	Size	Pkg. Qty.
T49001	21oz California Hammer (Curved Handle), Milled Face, Hickory Handle	21oz.	1
T49013	20oz Ripping Claw Hammer, Polished Face, Hickory Handle	20oz.	1
T49024	16oz Curved Claw Hammer, Polished Face, Hickory Handle	16oz.	1
T49032	3lb One Piece Forged Club Hammer, Polished Head, TPR Grip	3lb.	1
T49051	12oz Drywall Hammer, Milled Face, Hickory Handle	12oz.	1
T02001	Aviation Snips, TPR Grip	Straight Cut	6
T02002	Aviation Snips, TPR Grip	Left Cut	6
T02003	Aviation Snips, TPR Grip	Right Cut	6
T02004	Aviation Snips, TPR Grip	Notch Cut	6
T02005	Aviation Snips, TPR Grip	Long Cut	6
T06002	Tiger Paw Adjustable Wrench w/ Padded Handle, Matte Finish	6" Length	1
T06003	Tiger Paw Adjustable Wrench w/ Padded Handle, Matte Finish	8" Length	1
T06004	Tiger Paw Adjustable Wrench w/ Padded Handle, Matte Finish	10" Length	1
T06005	Tiger Paw Adjustable Wrench w/ Padded Handle, Matte Finish	12" Length	1
T08001	Plumbing Adjustable Wrench, Phos Finish	6" Length	1
T08002	Plumbing Adjustable Wrench, Phos Finish	8" Length	1
T08003	Plumbing Adjustable Wrench, Phos Finish	10" Length	1
T08004	Plumbing Adjustable Wrench, Phos Finish	12" Length	1
T11014	Pipe Wrench, Forged Steel - 14"	14"	1
T11018	Pipe Wrench, Forged Steel - 18"	18"	1
T15001	High Leverage Heavy Duty Lineman's Pliers, TPR Grip	8.5" Length	1
T15002	High Leverage Heavy Duty Lineman's Pliers, TPR Grip	9.5" Length	1
T16001	Straight Jaw Groove Joint Pliers, Coated Grip	8" Length	1
T16002	Straight Jaw Groove Joint Pliers, Coated Grip	10" Length	1
T16003	Straight Jaw Groove Joint Pliers, Coated Grip	12" Length	1
T18002	High Leverage Heavy Duty Diagonal Pliers, TPR Grip	7" Length	1
T18003	High Leverage Heavy Duty Diagonal Pliers, TPR Grip	8" Length	1
T20101	All Purpose 7 in 1 Plier	8"	1
T21002	Slip Joint Pliers, TPR Grip	8"	1
T23007	Curved Jaw Locking Pliers 7"	7"	1
T23010	Curved Jaw Locking Pliers 10"	10"	1
T23100	Locking C-Clamp 6"	6"	1
T23211	Locking C-Clamps with Swivel Pads 11"	11"	1
T23409	Long Nose Jaw Locking Pliers 9"	9"	1
T29001	Interchangeable (Stub) 5 in 1 Screwdriver	5 in 1	1
T29002	Interchangeable 9 in 1 Screwdriver	9 in 1	1
T29004	Interchangeable 19 in 1 Ratcheting Screwdriver	19 in 1	1



T49001



T49051



T02003



T06004



T08003



T15001



T16003



T20101



T29004



T23100



GENERAL PURPOSE

HAND TOOLS

Part No.	Item Description	Size	Pkg. Qty.
T40001	Iron Tacker Staple Gun (1/4" to 9/16") Staples	1/4" to 9/16"	1
T41001	Hammer Tacker (1/4" to 3/8") Staples	1/4" to 3/8"	1
T42001	Staples (1.2mm Thick, 10.6mm Wide)	1/4"	1
T42002	Staples (1.2mm Thick, 10.6mm Wide)	5/16"	1
T42003	Staples (1.2mm Thick, 10.6mm Wide)	3/8"	1
T42004	Staples (1.2mm Thick, 10.6mm Wide)	1/2"	1
T42005	Staples (1.2mm Thick, 10.6mm Wide)	9/16"	1
T53002	Heavy Duty Tape Measure w/Magnetic Hook	25'	1
T54001	Retractable Utility Knife	6"	6
T54005	Folding Utility Knife	4-1/2"	6
T55001	Blade (12 pcs. pack) 10 Packs per Case	2"	10
C20001	M2-HSS Drill Bit Set, (21 pc.) 1-1/16" to 3/8"	1/16" to 3/8"	1
C20002	M2-HSS Drill Bit Set, (29 pc.) 1/16" to 1/2"	1/16" to 1/2"	1
M12010	LED Flashlight, 260 Lumen, Non-Rechargeable	260 Lumen	1
M12020	LED Flashlight, 450 Lumen, Non-Rechargeable	450 Lumen	1
M12030	LED Flashlight, 700 Lumen, Rechargeable	700 Lumen	1
M12050	LED Portable Worklight, 1,400 Lumen, Rechargeable	1,400 Lumen	1
M20010	Packaging Tape, 2" x 110 yds. 1.8mil, Acrylic Clear	2" x 110yds.	36 rolls
M20011	Packaging Tape, 3" x 110 yds. 1.8mil, Acrylic Clear	3" x 110yds.	24 rolls
M20020	Packaging Tape, 2" x 110 yds. 1.8mil, Hot-Melt, Brown	2" x 110yds.	36 rolls
M20111	Packaging 3" Tape Dispensing Gun	3" Tape Gun	24 rolls
M21010	Duct Tape 1.88" X 60yds. 0.18mm General Purpose, Silver	2" x 60yds	36 rolls
M21011	Duct Tape 1.88" X 60yds. 0.18mm General Purpose, Black	2" x 60yds	36 rolls
M21020	Duct Tape 1.88" X 60yds. 0.225mm Heavy Duty, Silver	2" x 60yds	36 rolls
M23010	Vinyl Electrical Tape 3/4" x 66ft. 0.18mm, Black	3/4" X 66FT	10 rolls
M24010	Thread Sealing Tape, White, 1/2" x 43'	1/2" x 43'	50 rolls
M25010	Yellow / Black Caution Tape 3" x 1,000' (1.3mil)	3" x 1,000'	16 rolls
M25020	Red / Black Danger Tape 3" x 1,000' (1.3mil)	3" x 1,000'	16 rolls
M26010	Contractor Waste Bags, 4mil, 42 Gallon, (20 Per Box)	42 Gallon	1 box
M26011	Contractor Waste Bags, 3mil, 42 Gallon, (20 Per Box)	42 Gallon	1 box
T98003	Carpenter Pencil, 7"	7"	125 pcs.
T99001	USA Hand & Tool Wipes, 82 Wipes per Canister	82 Wipes	6
T99100	USA Shop Towels, 200 Sheets Per Box		4 boxes



T41001



T53002



T54001



C20002

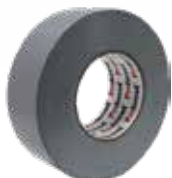

M21010



M21011



M25010



M26011



T99001

GENERAL PURPOSE PPE

NITRILE GLOVES - DISPOSABLE



Part No.	Item Description	Size	Pkg. Qty.
M01001	Disposable Nitrile Gloves, Powder-Free, (5mil) Blue	S	1,000
M01002	Disposable Nitrile Gloves, Powder-Free, (5mil) Blue	M	1,000
M01003	Disposable Nitrile Gloves, Powder-Free, (5mil) Blue	L	1,000
M01004	Disposable Nitrile Gloves, Powder-Free, (5mil) Blue	XL	1,000
M01005	Disposable Nitrile Gloves, Powder-Free, (5mil) Blue	XXL	1,000
M01006	Disposable Nitrile Gloves, Powder-Free, (5mil) Black	S	1,000
M01007	Disposable Nitrile Gloves, Powder-Free, (5mil) Black	M	1,000
M01008	Disposable Nitrile Gloves, Powder-Free, (5mil) Black	L	1,000
M01009	Disposable Nitrile Gloves, Powder-Free, (5mil) Black	XL	1,000
M01010	Disposable Nitrile Gloves, Powder-Free, (5mil) Black	XXL	1,000
M01020	Disposable Nitrile Gloves, Powder-Free, (8mil) Blue	S	1,000
M01021	Disposable Nitrile Gloves, Powder-Free, (8mil) Blue	M	1,000
M01022	Disposable Nitrile Gloves, Powder-Free, (8mil) Blue	L	1,000
M01023	Disposable Nitrile Gloves, Powder-Free, (8mil) Blue	XL	1,000
M01024	Disposable Nitrile Gloves, Powder-Free, (8mil) Blue	XXL	1,000





GENERAL PURPOSE PPE

INDUSTRIAL GLOVES



Part No.	Item Description	Size	Pkg. Qty.
M05001	Poly Cotton Knitted Industrial Gloves, Natural Color	S	6
M05002	Poly Cotton Knitted Industrial Gloves, Natural Color	L	6
M05005	Natural Canvas Industrial Gloves	S	6
M05006	Natural Canvas Industrial Gloves	L	6
M05010	Inspection Industrial Gloves	S	6
M05011	Inspection Industrial Gloves	L	6
M05015	A/B Cowhide Industrial Gloves, Double Palm	M	6
M05016	A/B Cowhide Industrial Gloves, Double Palm	L	6
M05020	Gray PU Coating /Gray Nylon Industrial Gloves	S	6
M05021	Gray PU Coating /Gray Nylon Industrial Gloves	M	6
M05022	Gray PU Coating /Gray Nylon Industrial Gloves	L	6
M05023	Gray PU Coating /Gray Nylon Industrial Gloves	XL	6
M05024	Gray PU Coating /Gray Nylon Industrial Gloves	XXL	6
M05025	Blue Latex/Gray Polyester Industrial Gloves	S	6
M05026	Blue Latex/Gray Polyester Industrial Gloves	M	6
M05027	Blue Latex/Gray Polyester Industrial Gloves	L	6
M05028	Blue Latex/Gray Polyester Industrial Gloves	XL	6
M05029	Blue Latex/Gray Polyester Industrial Gloves	XXL	6

GENERAL PURPOSE PPE

INDUSTRIAL GLOVES	Part No.	Item Description	Size	Pkg. Qty.
	M05030	Black Nitrile/Gray Liner Industrial Gloves	S	6
	M05031	Black Nitrile/Gray Liner Industrial Gloves	M	6
	M05032	Black Nitrile/Gray Liner Industrial Gloves	L	6
	M05033	Black Nitrile/Gray Liner Industrial Gloves	XL	6
	M05034	Black Nitrile/Gray Liner Industrial Gloves	XXL	6
	M05035	Black Nitrile/Gray Liner Industrial Gloves w/Palm Dots	S	6
	M05036	Black Nitrile/Gray Liner Industrial Gloves w/Palm Dots	M	6
	M05037	Black Nitrile/Gray Liner Industrial Gloves w/Palm Dots	L	6
	M05038	Black Nitrile/Gray Liner Industrial Gloves w/Palm Dots	XL	6
	M05039	Black Nitrile/Gray Liner Industrial Gloves w/Palm Dots	XXL	6
	M05101	Black PU Coating/Black Nylon Industrial Gloves	S	6
	M05102	Black PU Coating/Black Nylon Industrial Gloves	M	6
	M05103	Black PU Coating/Black Nylon Industrial Gloves	L	6
	M05104	Black PU Coating/Black Nylon Industrial Gloves	XL	6
	M05105	Black PU Coating/Black Nylon Industrial Gloves	XXL	6
	M05107	Hybrid Triple Polymer Coated Industrial Gloves	M	6
	M05108	Hybrid Triple Polymer Coated Industrial Gloves	L	6
	M05109	Hybrid Triple Polymer Coated Industrial Gloves	XL	6
	M05111	Mechanics Industrial Gloves	S	6
	M05112	Mechanics Industrial Gloves	M	6
	M05113	Mechanics Industrial Gloves	L	6
	M05114	Mechanics Industrial Gloves	XL	6
	M05115	Mechanics Industrial Gloves	XXL	6
	M05117	Pigskin Industrial/Truck Drivers Gloves	M	6
	M05118	Pigskin Industrial/Truck Drivers Gloves	L	6
	M05119	Pigskin Industrial/Truck Drivers Gloves	XL	6
	M05122	Cowhide Leather Industrial Gloves	M	6
	M05123	Cowhide Leather Industrial Gloves	L	6
	M05124	Cowhide Leather Industrial Gloves	XL	6

M05032

M05037

M05102

M05108

M05113

M05117

M05123

GENERAL PURPOSE PPE

INDUSTRIAL GLOVES



M05130



M06012



M06017



M06100



M06120

Part No.	Item Description	Size	Pkg. Qty.
M05127	Poly Cotton Knitted Gloves w/PVC Dots, Natural Color	S	6
M05128	Poly Cotton Knitted Gloves w/PVC Dots, Natural Color	L	6
M05129	Brown Jersey Gloves	M	6
M05130	Brown Jersey Gloves	L	6
M05131	Brown Jersey Gloves	XL	6
M06010	Gray PU/Gray HPPE Liner (Cut Level 2) Resistant Gloves	S	6
M06011	Gray PU/Gray HPPE Liner (Cut Level 2) Resistant Gloves	M	6
M06012	Gray PU/Gray HPPE Liner (Cut Level 2) Resistant Gloves	L	6
M06013	Gray PU/Gray HPPE Liner (Cut Level 2) Resistant Gloves	XL	6
M06014	Gray PU/Gray HPPE Liner (Cut Level 2) Resistant Gloves	XXL	6
M06015	Gray PU/Gray HPPE Liner (Cut Level 3) Resistant Gloves	S	6
M06016	Gray PU/Gray HPPE Liner (Cut Level 3) Resistant Gloves	M	6
M06017	Gray PU/Gray HPPE Liner (Cut Level 3) Resistant Gloves	L	6
M06018	Gray PU/Gray HPPE Liner (Cut Level 3) Resistant Gloves	XL	6
M06019	Gray PU/Gray HPPE Liner (Cut Level 3) Resistant Gloves	XXL	6
M06100	ANSI (Cut Level 4) Resistant Gloves	S	6
M06101	ANSI (Cut Level 4) Resistant Gloves	M	6
M06102	ANSI (Cut Level 4) Resistant Gloves	L	6
M06103	ANSI (Cut Level 4) Resistant Gloves	X	6
M06104	ANSI (Cut Level 4) Resistant Gloves	XXL	6
M06120	ANSI (Cut Level 6) Resistant Gloves	S	6
M06121	ANSI (Cut Level 6) Resistant Gloves	M	6
M06122	ANSI (Cut Level 6) Resistant Gloves	L	6
M06123	ANSI (Cut Level 6) Resistant Gloves	X	6
M06124	ANSI (Cut Level 6) Resistant Gloves	XXL	6

GENERAL PURPOSE PPE

SAFETY GLASSES



M15102

Part No.	Item Description	Size	Pkg. Qty.
M15100	100 Clear Lens HC Safety Glasses,	Universal	12
M15101	100 Clear Lens AS&AF Safety Glasses,	Universal	12
M15102	100 Smoke Lens HC Safety Glasses	Universal	12
M15103	100 Smoke Lens AS&AF Safety Glasses	Universal	12
M15104	100 Yellow/Amber Lens HC Safety Glasses	Universal	12
M15106	100 I/O Mirror Lens Safety Glasses	Universal	12
M15110	100 Clear Bifocal +1.0 HC Safety Glasses	Universal	12
M15111	100 Clear Bifocal +1.5 HC Safety Glasses	Universal	12
M15112	100 Clear Bifocal +2.0 HC Safety Glasses	Universal	12
M15113	100 Clear Bifocal +2.5 HC Safety Glasses	Universal	12
M15114	100 Clear Bifocal +3.0 HC Safety Glasses	Universal	12
M15120	100 Clear Mini Lens HC Safety Glasses	Mini	12
M15121	100 Clear Mini Lens AS&AF Safety Glasses	Mini	12
M15122	100 Smoke Mini Lens HC Safety Glasses	Mini	12

• ANSI Z87.1 Compliant

GENERAL PURPOSE PPE

SAFETY GLASSES



M15220



M15300

• ANSI Z87.1 Compliant

Part No.	Item Description	Size	Pkg. Qty.
M15123	100 Smoke Lens AS&AF Safety Glasses	Universal	12
M15200	200 Clear Lens HC Safety Glasses	Universal	12
M15202	200 Smoke Lens HC Safety Glasses	Universal	12
M15210	210 Clear Lens HC Safety Glasses	Universal	12
M15211	210 Clear Lens AS&AF Safety Glasses	Universal	12
M15212	210 Smoke Lens HC Safety Glasses	Universal	12
M15213	210 Smoke Lens AS&AF Safety Glasses	Universal	12
M15214	210 Yellow/Amber HC Safety Glasses	Universal	12
M15216	210 I/O Mirror Lens Safety Glasses	Universal	12
M15220	220 Silver Mirror Lens HC Safety Glasses	Universal	12
M15230	220 Clear Lens HC Safety Glasses	Universal	12
M15240	240 Clear Lens Over Glasses, Safety Glasses	Universal	12
M15300	G100 Cleans Lens Safety Goggles	Universal	12

GENERAL PURPOSE PPE

SAFETY VESTS



M18001



M18040



M18100

Part No.	Item Description	Size	Pkg. Qty.
M18001	Universal Reflective Vest, Non-Rated	Universal	1
M18010	Yellow, (Class 2) 5-Point Breakaway Safety Vest, 2 Pockets	M	1
M18011	Yellow, (Class 2) 5-Point Breakaway Safety Vest, 2 Pockets	L	1
M18012	Yellow, (Class 2) 5-Point Breakaway Safety Vest, 2 Pockets	XL	1
M18013	Yellow, (Class 2) 5-Point Breakaway Safety Vest, 2 Pockets	2XL	1
M18020	Orange, (Class 2) 5-Point Breakaway Safety Vest, 2 Pockets	M	1
M18021	Orange, (Class 2) 5-Point Breakaway Safety Vest, 2 Pockets	L	1
M18022	Orange, (Class 2) 5-Point Breakaway Safety Vest, 2 Pockets	XL	1
M18023	Orange, (Class 2) 5-Point Breakaway Safety Vest, 2 Pockets	2XL	1
M18030	Lime, Hi-Vis ANSI (Class 2) Safety Vest, Single Pocket	M	1
M18031	Lime, Hi-Vis ANSI (Class 2) Safety Vest, Single Pocket	L	1
M18032	Lime, Hi-Vis ANSI (Class 2) Safety Vest, Single Pocket	XL	1
M18033	Lime, Hi-Vis ANSI (Class 2) Safety Vest, Single Pocket	2XL	1
M18040	Orange, Hi-Vis ANSI (Class 2) Safety Vest, Single Pocket	M	1
M18041	Orange, Hi-Vis ANSI (Class 2) Safety Vest, Single Pocket	L	1
M18042	Orange, Hi-Vis ANSI (Class 2) Safety Vest, Single Pocket	XL	1
M18043	Orange, Hi-Vis ANSI (Class 2) Safety Vest, Single Pocket	2XL	1
M18100	Lime, Hi-Vis ANSI (Class 3) Safety Vest, 4 Pockets	S	1
M18101	Lime, Hi-Vis ANSI (Class 3) Safety Vest, 4 Pockets	M	1
M18102	Lime, Hi-Vis ANSI (Class 3) Safety Vest, 4 Pockets	L	1
M18103	Lime, Hi-Vis ANSI (Class 3) Safety Vest, 4 Pockets	XL	1
M18104	Lime, Hi-Vis ANSI (Class 3) Safety Vest, 4 Pockets	2XL	1
M18105	Lime, Hi-Vis ANSI (Class 3) Safety Vest, 4 Pockets	3XL	1
M18106	Lime, Hi-Vis ANSI (Class 3) Safety Vest, 4 Pockets	4XL	1
M18107	Lime, Hi-Vis ANSI (Class 3) Safety Vest, 4 Pockets	5XL	1

GENERAL PURPOSE PPE

SAFETY VESTS



M18110

Part No.	Item Description	Size	Pkg. Qty.
M18110	Orange, Hi-Vis ANSI (Class 3) Safety Vest, 4 Pockets	S	1
M18111	Orange, Hi-Vis ANSI (Class 3) Safety Vest, 4 Pockets	M	1
M18112	Orange, Hi-Vis ANSI (Class 3) Safety Vest, 4 Pockets	L	1
M18113	Orange, Hi-Vis ANSI (Class 3) Safety Vest, 4 Pockets	XL	1
M18114	Orange, Hi-Vis ANSI (Class 3) Safety Vest, 4 Pockets	2XL	1
M18115	Orange, Hi-Vis ANSI (Class 3) Safety Vest, 4 Pockets	3XL	1
M18116	Orange, Hi-Vis ANSI (Class 3) Safety Vest, 4 Pockets	4XL	1
M18117	Orange, Hi-Vis ANSI (Class 3) Safety Vest, 4 Pockets	5XL	1

GENERAL PURPOSE PPE

PROTECTIVE EQUIPMENT



M09010



M09020



M14003



M17020



M17050

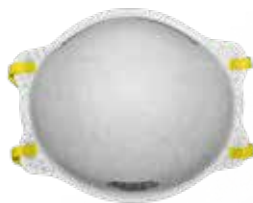

M19020

Part No.	Item Description	Size	Pkg. Qty.
M09010	Curved Gel Knee Pads w/Velcro Straps	Universal	2
M09020	Block Stationary Gel Knee Pads w/Velcro Straps	Universal	2
M12041	Rechargeable LED Portable Work Light	1,000 Lumen	1
M13010	24" White, Pleated Bouffant Cap	24"	
M13020	Universal, Blue, Shoe Covers	Universal	
M14001	Universal, Yellow Poncho Rain Cover	Universal	1
M14003	Yellow, Plastic Rain Coat w/Detachable Hood	S	1
M14004	Yellow, Plastic Rain Coat w/Detachable Hood	M	1
M14005	Yellow, Plastic Rain Coat w/Detachable Hood	L	1
M14006	Yellow, Plastic Rain Coat w/Detachable Hood	XL	1
M14007	Yellow, Plastic Rain Coat w/Detachable Hood	2XL	1
M14008	Yellow, Plastic Rain Coat w/Detachable Hood	3XL	1
M14009	Yellow, Plastic Rain Coat w/Detachable Hood	4XL	1
M17010	PU Foam Ear Plugs	Universal	
M17020	PU Foam Ear Plugs, Corded	Universal	
M17030	Silicone Ear Plugs, Corded	Universal	
M17050	Folding Earmuffs	Universal	1
M19020	N95 Particulate Disposable Respirator Mask, (20 pcs. box)	Universal	1
M19021	N95 Particulate Disposable Respirator Mask w/Valve, (10 pcs. Box)	Universal	1





**THE ULTIMATE IN ANCHORS &
ANCHOR CERTIFICATIONS**





TAPKING^{SD}



The Ultimate Concrete Screw

CONCRETE - For Medium Duty Anchoring To Concrete And Masonry Products - Blue Durable Coat

CONCRETE SCREWS	Part No.	Item Description	Size	Box Qty.
  <div style="border: 1px solid red; padding: 5px; width: fit-content; margin: 10px auto;"> <p>Drive Bit: PH-2 for 3/16" diameter PH-3 for 1/4" diameter</p> </div>	660200	Tapking SD, Flat Head Phil, Concrete Screws, Blue Durablecoat	3/16" x 1 1/4"	100
	660210	Tapking SD, Flat Head Phil, Concrete Screws, Blue Durablecoat	3/16" x 1 3/4"	100
	660220	Tapking SD, Flat Head Phil, Concrete Screws, Blue Durablecoat	3/16" x 2 1/4"	100
	660230	Tapking SD, Flat Head Phil, Concrete Screws, Blue Durablecoat	3/16" x 2 3/4"	100
	660240	Tapking SD, Flat Head Phil, Concrete Screws, Blue Durablecoat	3/16" x 3 1/4"	100
	660250	Tapking SD, Flat Head Phil, Concrete Screws, Blue Durablecoat	3/16" x 4"	100
	660260	Tapking SD, Flat Head Phil, Concrete Screws, Blue Durablecoat	1/4" x 1 1/4"	100
	660270	Tapking SD, Flat Head Phil, Concrete Screws, Blue Durablecoat	1/4" x 1 3/4"	100
	660280	Tapking SD, Flat Head Phil, Concrete Screws, Blue Durablecoat	1/4" x 2 1/4"	100
	660290	Tapking SD, Flat Head Phil, Concrete Screws, Blue Durablecoat	1/4" x 2 3/4"	100
	660300	Tapking SD, Flat Head Phil, Concrete Screws, Blue Durablecoat	1/4" x 3 1/4"	100
	660310	Tapking SD, Flat Head Phil, Concrete Screws, Blue Durablecoat	1/4" x 4"	100
	660320	Tapking SD, Flat Head Phil, Concrete Screws, Blue Durablecoat	1/4" x 5"	100
	660330	Tapking SD, Flat Head Phil, Concrete Screws, Blue Durablecoat	1/4" x 6"	100

• Miami-Dade County Approval • Durable Coat = 1,000 hour salt spray, providing superior corrosion resistance • Available in bulk



TAPKING^{SD}



The Ultimate Concrete Screw

CONCRETE - For Medium Duty Anchoring To Concrete And Masonry Products - Blue Durable Coat

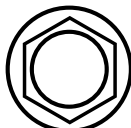
CONCRETE SCREWS	Part No.	Item Description	Size	Box Qty.
  <div style="border: 1px solid red; padding: 5px; width: fit-content; margin: 10px auto;"> <p>Hex Drive Bit Size Varies Depending On Screw Diameter Size</p> </div>	660010	Tapking SD, Indent HWH Head, Concrete Screws, Blue Durablecoat	3/16" x 1 1/4"	100
	660015	Tapking SD, Indent HWH Head, Concrete Screws, Blue Durablecoat	3/16" x 1 3/4"	100
	660020	Tapking SD, Indent HWH Head, Concrete Screws, Blue Durablecoat	3/16" x 2 1/4"	100
	660025	Tapking SD, Indent HWH Head, Concrete Screws, Blue Durablecoat	3/16" x 2 3/4"	100
	660030	Tapking SD, Indent HWH Head, Concrete Screws, Blue Durablecoat	3/16" x 3 1/4"	100
	660035	Tapking SD, Indent HWH Head, Concrete Screws, Blue Durablecoat	3/16" x 4"	100
	660050	Tapking SD, Indent HWH Head, Concrete Screws, Blue Durablecoat	1/4" x 1 1/4"	100
	660055	Tapking SD, Indent HWH Head, Concrete Screws, Blue Durablecoat	1/4" x 1 3/4"	100
	660060	Tapking SD, Indent HWH Head, Concrete Screws, Blue Durablecoat	1/4" x 2 1/4"	100
	660070	Tapking SD, Indent HWH Head, Concrete Screws, Blue Durablecoat	1/4" x 2 3/4"	100
	660080	Tapking SD, Indent HWH Head, Concrete Screws, Blue Durablecoat	1/4" x 3 1/4"	100
	660090	Tapking SD, Indent HWH Head, Concrete Screws, Blue Durablecoat	1/4" x 4"	100
	660100	Tapking SD, Indent HWH Head, Concrete Screws, Blue Durablecoat	1/4" x 5"	100
	660110	Tapking SD, Indent HWH Head, Concrete Screws, Blue Durablecoat	1/4" x 6"	100

• Miami-Dade County Approval • Durable Coat = 1,000 hour salt spray, providing superior corrosion resistance • Available in bulk



TAPKING^{SD}



The Ultimate Concrete Screw

CONCRETE - For Medium Duty Anchoring To Concrete And Masonry Products - Zinc Plating

CONCRETE SCREWS	Part No.	Item Description	Size	Box Qty.
 	660410	Tapking SD, Trim Head Phil, Concrete Screws, White Durablecoat	1/4" x 1 3/4"	100
	660420	Tapking SD, Trim Head Phil, Concrete Screws, White Durablecoat	1/4" x 2 1/4"	100
	660430	Tapking SD, Trim Head Phil, Concrete Screws, White Durablecoat	1/4" x 2 3/4"	100
	660440	Tapking SD, Trim Head Phil, Concrete Screws, White Durablecoat	1/4" x 3 1/4"	100
	660450	Tapking SD, Trim Head Phil, Concrete Screws, White Durablecoat	1/4" x 3 3/4"	100
	660460	Tapking SD, Trim Head Phil, Concrete Screws, White Durablecoat	1/4" x 4"	100
	660620	Tapking SD, Trim Head Phil, Concrete Screws, Bronze Durablecoat	1/4" x 2 1/4"	100
	660630	Tapking SD, Trim Head Phil, Concrete Screws, Bronze Durablecoat	1/4" x 2 3/4"	100
	660640	Tapking SD, Trim Head Phil, Concrete Screws, Bronze Durablecoat	1/4" x 3 1/4"	100
	660820	Tapking SD, Trim Head Phil, Concrete Screws, Silver Durablecoat	1/4" x 2 1/4"	100
	660830	Tapking SD, Trim Head Phil, Concrete Screws, Silver Durablecoat	1/4" x 2 3/4"	100
	660840	Tapking SD, Trim Head Phil, Concrete Screws, Silver Durablecoat	1/4" x 3 1/4"	100
	660850	Tapking SD, Trim Head Phil, Concrete Screws, Silver Durablecoat	1/4" x 3 3/4"	100
	660860	Tapking SD, Trim Head Phil, Concrete Screws, Silver Durablecoat	1/4" x 4"	100

Drive Bit: PH-2

- Miami-Dade County Approval
- Durable Coat = 1,000 hour salt spray, providing superior corrosion resistance
- Available in bulk



TAPKING^{HD}



The Ultimate Concrete Screw

CONCRETE - For Installing Racking, Shelving, Railings, Handrails, Ledgers, Signals, Stadium Seating And More - White, Bronze, Silver

HD CONCRETE SCREWS	Part No.	Item Description	Size	Box Qty.
 <ul style="list-style-type: none"> • ICC-ES 4557 Approved for cracked & uncracked concrete • Approved for use in static, wind and seismic • Code Listed: IBC/IRC in accordance with ICC-ES AC 193 & ACI 355.2 • Code Compliance: IBC 2018, 2015, 2013, 2009. IRC 2018, 2015, 2013, 2009. LABC 2017. LARC 2017. CBC 2019, 2016. CRC 2019, 2016. FBC 2017 • Patented Triple Thread® stabilizes installation for superior performance 	044103	Tapking HD Concrete Screw Anchor Zinc CR+3	3/8"x3"	50
	044104	Tapking HD Concrete Screw Anchor Zinc CR+3	3/8"x4"	50
	044105	Tapking HD Concrete Screw Anchor Zinc CR+3	3/8"x5"	50
	044106	Tapking HD Concrete Screw Anchor Zinc CR+3	3/8"x6"	50
	044123	Tapking HD Concrete Screw Anchor Zinc CR+3	1/2"x4"	50
	044124	Tapking HD Concrete Screw Anchor Zinc CR+3	1/2"x5"	25
	044125	Tapking HD Concrete Screw Anchor Zinc CR+3	1/2"x6"	25
	044126	Tapking HD Concrete Screw Anchor Zinc CR+3	1/2"x6-1/2"	25
	044127	Tapking HD Concrete Screw Anchor Zinc CR+3	1/2"x8"	20
	044162	Tapking HD Concrete Screw Anchor Zinc CR+3	5/8"x4"	25
	044163	Tapking HD Concrete Screw Anchor Zinc CR+3	5/8"x5"	25
	044164	Tapking HD Concrete Screw Anchor Zinc CR+3	5/8"x6"	20
	044165	Tapking HD Concrete Screw Anchor Zinc CR+3	5/8"x6-1/2"	20
	044166	Tapking HD Concrete Screw Anchor Zinc CR+3	5/8"x8"	20
	044202	Tapking HD Concrete Screw Anchor Zinc CR+3	3/4"x4-1/2"	20
	044203	Tapking HD Concrete Screw Anchor Zinc CR+3	3/4"x5"	15
	044204	Tapking HD Concrete Screw Anchor Zinc CR+3	3/4"x5-1/2"	15
	044205	Tapking HD Concrete Screw Anchor Zinc CR+3	3/4"x6"	10
	044206	Tapking HD Concrete Screw Anchor Zinc CR+3	3/4"x6-1/4"	10
	044207	Tapking HD Concrete Screw Anchor Zinc CR+3	3/4"x7"	10
044208	Tapking HD Concrete Screw Anchor Zinc CR+3	3/4"x8"	10	
044209	Tapking HD Concrete Screw Anchor Zinc CR+3	3/4"x8-1/2"	10	
044210	Tapking HD Concrete Screw Anchor Zinc CR+3	3/4"x10"	10	





ICC APPROVED FOR CRACKED & UNCRACKED CONCRETE



The Ultimate Wedge Anchor for Cracked & Uncracked Concrete

CONCRETE - For Anchoring Racking And Products To Concrete Foundations - Zinc Plated

ULTRAWEDGE+ ANCHORS

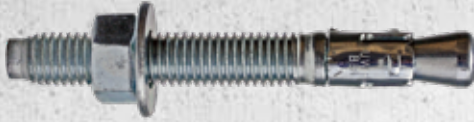

- ICC and Miami-Dade County Approved
- Trademarked for quality
- 360° degree collar
- 1035 cold rolled steel
- Longer thread length
- Superior performance in cracked & uncracked concrete
- Head stamp for anchor length identification

Part No.	Item Description	Size	Case Qty.
157060	ULTRAWEDGE+ Concrete Wedge Anchors, Zinc Plated CR+3	3/8"-16x2 1/4"	100
157070	ULTRAWEDGE+ Concrete Wedge Anchors, Zinc Plated CR+3	3/8"-16x2 3/4"	100
157080	ULTRAWEDGE+ Concrete Wedge Anchors, Zinc Plated CR+3	3/8"-16x3"	100
157090	ULTRAWEDGE+ Concrete Wedge Anchors, Zinc Plated CR+3	3/8"-16x3 3/4"	100
157100	ULTRAWEDGE+ Concrete Wedge Anchors, Zinc Plated CR+3	3/8"-16x5"	50
157110	ULTRAWEDGE+ Concrete Wedge Anchors, Zinc Plated CR+3	3/8"-16x6 1/2"	50
157180	ULTRAWEDGE+ Concrete Wedge Anchors, Zinc Plated CR+3	1/2"-13x2 3/4"	50
157190	ULTRAWEDGE+ Concrete Wedge Anchors, Zinc Plated CR+3	1/2"-13x3 3/4"	50
157200	ULTRAWEDGE+ Concrete Wedge Anchors, Zinc Plated CR+3	1/2"-13x4 1/4"	25
157210	ULTRAWEDGE+ Concrete Wedge Anchors, Zinc Plated CR+3	1/2"-13x4 1/2"	25
157220	ULTRAWEDGE+ Concrete Wedge Anchors, Zinc Plated CR+3	1/2"-13x5 1/2"	25
157230	ULTRAWEDGE+ Concrete Wedge Anchors, Zinc Plated CR+3	1/2"-13x7"	25
157240	ULTRAWEDGE+ Concrete Wedge Anchors, Zinc Plated CR+3	1/2"-13x8 1/2"	25
157250	ULTRAWEDGE+ Concrete Wedge Anchors, Zinc Plated CR+3	1/2"-13x10"	25
157260	ULTRAWEDGE+ Concrete Wedge Anchors, Zinc Plated CR+3	1/2"-13x12"	25
157300	ULTRAWEDGE+ Concrete Wedge Anchors, Zinc Plated CR+3	5/8"-11x3 1/2"	25
157310	ULTRAWEDGE+ Concrete Wedge Anchors, Zinc Plated CR+3	5/8"-11x4 1/2"	25
157320	ULTRAWEDGE+ Concrete Wedge Anchors, Zinc Plated CR+3	5/8"-11x5"	25
157330	ULTRAWEDGE+ Concrete Wedge Anchors, Zinc Plated CR+3	5/8"-11x6"	25
157340	ULTRAWEDGE+ Concrete Wedge Anchors, Zinc Plated CR+3	5/8"-11x7"	25
157350	ULTRAWEDGE+ Concrete Wedge Anchors, Zinc Plated CR+3	5/8"-11x8 1/2"	25
157360	ULTRAWEDGE+ Concrete Wedge Anchors, Zinc Plated CR+3	5/8"-11x10"	10
157370	ULTRAWEDGE+ Concrete Wedge Anchors, Zinc Plated CR+3	5/8"-11x12"	10
157380	ULTRAWEDGE+ Concrete Wedge Anchors, Zinc Plated CR+3	3/4"-10x4 1/4"	20
157390	ULTRAWEDGE+ Concrete Wedge Anchors, Zinc Plated CR+3	3/4"-10x4 3/4"	20
157400	ULTRAWEDGE+ Concrete Wedge Anchors, Zinc Plated CR+3	3/4"-10x5 1/2"	20
157410	ULTRAWEDGE+ Concrete Wedge Anchors, Zinc Plated CR+3	3/4"-10x6 1/4"	10
157420	ULTRAWEDGE+ Concrete Wedge Anchors, Zinc Plated CR+3	3/4"-10x7"	10
157430	ULTRAWEDGE+ Concrete Wedge Anchors, Zinc Plated CR+3	3/4"-10x8 1/2"	10
157440	ULTRAWEDGE+ Concrete Wedge Anchors, Zinc Plated CR+3	3/4"-10x10"	10
157450	ULTRAWEDGE+ Concrete Wedge Anchors, Zinc Plated CR+3	3/4"-10x12"	10



Where Quality and Performance Comes First!
ASTM E488 Tested

CONCRETE - For Anchoring Products Requiring High Quality Corrosion Resistance - Stainless 304

ULTRAWEDGE ANCHORS



- Trademarked for quality
- 360° degree collar
- 304 Stainless
- Longer thread length
- Head stamp for anchor length identification

Part No.	Item Description	Size	Case Qty.
616010	ULTRAWEDGE Concrete Wedge Anchors, 304 Stainless	1/4"-20 x 1 3/4"	100
616020	ULTRAWEDGE Concrete Wedge Anchors, 304 Stainless	1/4"-20 x 2 1/4"	100
616030	ULTRAWEDGE Concrete Wedge Anchors, 304 Stainless	1/4"-20 x 3 1/4"	100
616040	ULTRAWEDGE Concrete Wedge Anchors, 304 Stainless	3/8"-16 x 2 1/4"	100
616050	ULTRAWEDGE Concrete Wedge Anchors, 304 Stainless	3/8"-16 x 2 3/4"	100
616060	ULTRAWEDGE Concrete Wedge Anchors, 304 Stainless	3/8"-16 x 3"	100
616070	ULTRAWEDGE Concrete Wedge Anchors, 304 Stainless	3/8"-16 x 3 3/4"	100
616080	ULTRAWEDGE Concrete Wedge Anchors, 304 Stainless	3/8"-16 x 5"	50
616090	ULTRAWEDGE Concrete Wedge Anchors, 304 Stainless	3/8"-16 x 6 1/2"	50
616100	ULTRAWEDGE Concrete Wedge Anchors, 304 Stainless	1/2"-13 x 2 3/4"	50
616110	ULTRAWEDGE Concrete Wedge Anchors, 304 Stainless	1/2"-13 x 3 3/4"	50
616120	ULTRAWEDGE Concrete Wedge Anchors, 304 Stainless	1/2"-13 x 4 1/4"	25
616130	ULTRAWEDGE Concrete Wedge Anchors, 304 Stainless	1/2"-13 x 5 1/2"	25
616140	ULTRAWEDGE Concrete Wedge Anchors, 304 Stainless	1/2"-13 x 7"	25
616150	ULTRAWEDGE Concrete Wedge Anchors, 304 Stainless	1/2"-13 x 8 1/2"	25
616160	ULTRAWEDGE Concrete Wedge Anchors, 304 Stainless	1/2"-13 x 10"	25
616170	ULTRAWEDGE Concrete Wedge Anchors, 304 Stainless	1/2"-13 x 12"	25
616180	ULTRAWEDGE Concrete Wedge Anchors, 304 Stainless	5/8"-11 x 3 1/2"	25
616190	ULTRAWEDGE Concrete Wedge Anchors, 304 Stainless	5/8"-11 x 4 1/2"	25
616200	ULTRAWEDGE Concrete Wedge Anchors, 304 Stainless	5/8"-11 x 5"	25
616210	ULTRAWEDGE Concrete Wedge Anchors, 304 Stainless	5/8"-11 x 6"	25
616220	ULTRAWEDGE Concrete Wedge Anchors, 304 Stainless	5/8"-11 x 7"	25
616230	ULTRAWEDGE Concrete Wedge Anchors, 304 Stainless	5/8"-11 x 8 1/2"	25
616240	ULTRAWEDGE Concrete Wedge Anchors, 304 Stainless	5/8"-11 x 10"	10
616250	ULTRAWEDGE Concrete Wedge Anchors, 304 Stainless	5/8"-11 x 12"	10
616260	ULTRAWEDGE Concrete Wedge Anchors, 304 Stainless	3/4"-10 x 4 1/4"	20
616270	ULTRAWEDGE Concrete Wedge Anchors, 304 Stainless	3/4"-10 x 4 3/4"	20
616280	ULTRAWEDGE Concrete Wedge Anchors, 304 Stainless	3/4"-10 x 5 1/2"	20
616290	ULTRAWEDGE Concrete Wedge Anchors, 304 Stainless	3/4"-10 x 7"	10
616300	ULTRAWEDGE Concrete Wedge Anchors, 304 Stainless	3/4"-10 x 8 1/2"	10
616310	ULTRAWEDGE Concrete Wedge Anchors, 304 Stainless	3/4"-10 x 10"	10
616320	ULTRAWEDGE Concrete Wedge Anchors, 304 Stainless	3/4"-10 x 12"	10
616330	ULTRAWEDGE Concrete Wedge Anchors, 304 Stainless	3/4"-10 x 6 1/4"	10
616340	ULTRAWEDGE Concrete Wedge Anchors, 304 Stainless	7/8"-9 x 6"	5
616350	ULTRAWEDGE Concrete Wedge Anchors, 304 Stainless	7/8"-9 x 8"	5
616360	ULTRAWEDGE Concrete Wedge Anchors, 304 Stainless	1"-8 x 6"	5
616370	ULTRAWEDGE Concrete Wedge Anchors, 304 Stainless	1"-8 x 9"	5
616380	ULTRAWEDGE Concrete Wedge Anchors, 304 Stainless	1"-8 x 12"	5



**Where Quality and
Performance Comes First!
ASTM E488 Tested**

CONCRETE - For Anchoring Products Requiring Superior Corrosion Resistance - Stainless 316

ULTRAWEDGE ANCHORS



- Trademarked for quality
- 360° degree collar
- 316 Stainless
- Longer thread length
- Head stamp for anchor length identification

Part No.	Item Description	Size	Case Qty.
617010	ULTRAWEDGE Concrete Wedge Anchors, 316 Stainless	1/4"-20 x 1 3/4"	100
617020	ULTRAWEDGE Concrete Wedge Anchors, 316 Stainless	1/4"-20 x 2 1/4"	100
617030	ULTRAWEDGE Concrete Wedge Anchors, 316 Stainless	1/4"-20 x 3 1/4"	100
617040	ULTRAWEDGE Concrete Wedge Anchors, 316 Stainless	3/8"-16 x 2 3/4"	100
617050	ULTRAWEDGE Concrete Wedge Anchors, 316 Stainless	3/8"-16 x 3"	100
617060	ULTRAWEDGE Concrete Wedge Anchors, 316 Stainless	3/8"-16 x 3 3/4"	100
617070	ULTRAWEDGE Concrete Wedge Anchors, 316 Stainless	3/8"-16 x 5"	50
617080	ULTRAWEDGE Concrete Wedge Anchors, 316 Stainless	1/2"-13 x 2 3/4"	50
617090	ULTRAWEDGE Concrete Wedge Anchors, 316 Stainless	1/2"-13 x 3 3/4"	50
617100	ULTRAWEDGE Concrete Wedge Anchors, 316 Stainless	1/2"-13 x 4 1/4"	25
617110	ULTRAWEDGE Concrete Wedge Anchors, 316 Stainless	1/2"-13 x 5 1/2"	25
617120	ULTRAWEDGE Concrete Wedge Anchors, 316 Stainless	1/2"-13 x 7"	25
617130	ULTRAWEDGE Concrete Wedge Anchors, 316 Stainless	5/8"-11 x 3 1/2"	25
617140	ULTRAWEDGE Concrete Wedge Anchors, 316 Stainless	5/8"-11 x 4 1/2"	25
617150	ULTRAWEDGE Concrete Wedge Anchors, 316 Stainless	5/8"-11 x 5"	25
617160	ULTRAWEDGE Concrete Wedge Anchors, 316 Stainless	5/8"-11 x 6"	25
617170	ULTRAWEDGE Concrete Wedge Anchors, 316 Stainless	5/8"-11 x 7"	25
617180	ULTRAWEDGE Concrete Wedge Anchors, 316 Stainless	5/8"-11 x 8 1/2"	25
617190	ULTRAWEDGE Concrete Wedge Anchors, 316 Stainless	3/4"-10 x 4 1/4"	20
617200	ULTRAWEDGE Concrete Wedge Anchors, 316 Stainless	3/4"-10 x 4 3/4"	20
617210	ULTRAWEDGE Concrete Wedge Anchors, 316 Stainless	3/4"-10 x 5 1/2"	20
617220	ULTRAWEDGE Concrete Wedge Anchors, 316 Stainless	3/4"-10 x 6 1/4"	10
617230	ULTRAWEDGE Concrete Wedge Anchors, 316 Stainless	3/4"-10 x 7"	10
617240	ULTRAWEDGE Concrete Wedge Anchors, 316 Stainless	3/4"-10 x 8 1/2"	10



Where Quality and Performance Comes First!
ASTM E488 Tested

CONCRETE - For Anchoring Products Requiring High Quality Corrosion Resistance - Hot Dip Galvanized

ULTRAWEDGE ANCHORS

Part No.	Item Description	Size	Case Qty.
158010	ULTRAWEDGE Concrete Wedge Anchors, HDG	3/8"-16 x 3 1/2"	100
158100	ULTRAWEDGE Concrete Wedge Anchors, HDG	1/2"-13 x 2 3/4"	50
158110	ULTRAWEDGE Concrete Wedge Anchors, HDG	1/2"-13 x 3 3/4"	50
158120	ULTRAWEDGE Concrete Wedge Anchors, HDG	1/2"-13 x 4 1/4"	25
158130	ULTRAWEDGE Concrete Wedge Anchors, HDG	1/2"-13 x 5 1/2"	25
158140	ULTRAWEDGE Concrete Wedge Anchors, HDG	1/2"-13 x 7"	25
158150	ULTRAWEDGE Concrete Wedge Anchors, HDG	1/2"-13 x 8 1/2"	25
158160	ULTRAWEDGE Concrete Wedge Anchors, HDG	1/2"-13 x 10"	25
158200	ULTRAWEDGE Concrete Wedge Anchors, HDG	5/8"-11 x 3 1/2"	25
158210	ULTRAWEDGE Concrete Wedge Anchors, HDG	5/8"-11 x 5"	25
158220	ULTRAWEDGE Concrete Wedge Anchors, HDG	5/8"-11 x 6"	25
158230	ULTRAWEDGE Concrete Wedge Anchors, HDG	5/8"-11 x 7"	25
158240	ULTRAWEDGE Concrete Wedge Anchors, HDG	5/8"-11 x 8 1/2"	25
158250	ULTRAWEDGE Concrete Wedge Anchors, HDG	5/8"-11 x 10"	10
158300	ULTRAWEDGE Concrete Wedge Anchors, HDG	3/4"-10 x 4 3/4"	20
158310	ULTRAWEDGE Concrete Wedge Anchors, HDG	3/4"-10 x 5 1/2"	20
158320	ULTRAWEDGE Concrete Wedge Anchors, HDG	3/4"-10 x 6 1/4"	10
158330	ULTRAWEDGE Concrete Wedge Anchors, HDG	3/4"-10 x 8 1/2"	10
158340	ULTRAWEDGE Concrete Wedge Anchors, HDG	3/4"-10 x 10"	10
158400	ULTRAWEDGE Concrete Wedge Anchors, HDG	7/8"-9 x 6"	5
158410	ULTRAWEDGE Concrete Wedge Anchors, HDG	7/8"-9 x 8"	5
158500	ULTRAWEDGE Concrete Wedge Anchors, HDG	1"-8 x 6"	5
158510	ULTRAWEDGE Concrete Wedge Anchors, HDG	1"-8 x 9"	5



- Trademarked for quality
- 360° degree collar
- Longer thread length
- Head stamp for anchor length identification



The Ultimate Sleeve Anchor

HOLLOW BLOCK - Medium Duty Anchor For Installing Gates And Materials To Hollow Block - Zinc Plated

SLEEVE ANCHORS - HEX HEAD

Part No.	Item Description	Size	Case Qty.
278030	Sleeve Anchor w/Hex Nut, Zinc Plated CR+3	5/16" x 1 1/2"	100
278040	Sleeve Anchor w/Hex Nut, Zinc Plated CR+3	5/16" x 2 1/2"	100
278050	Sleeve Anchor w/Hex Nut, Zinc Plated CR+3	3/8" x 1 7/8"	50
278060	Sleeve Anchor w/Hex Nut, Zinc Plated CR+3	3/8" x 3"	50
278070	Sleeve Anchor w/Hex Nut, Zinc Plated CR+3	3/8" x 4"	50
278080	Sleeve Anchor w/Hex Nut, Zinc Plated CR+3	1/2" x 2 1/4"	25
278090	Sleeve Anchor w/Hex Nut, Zinc Plated CR+3	1/2" x 3"	25
278100	Sleeve Anchor w/Hex Nut, Zinc Plated CR+3	1/2" x 4"	25
278110	Sleeve Anchor w/Hex Nut, Zinc Plated CR+3	1/2" x 6"	25
278120	Sleeve Anchor w/Hex Nut, Zinc Plated CR+3	5/8" x 2 1/4"	25
278130	Sleeve Anchor w/Hex Nut, Zinc Plated CR+3	5/8" x 3"	25
278140	Sleeve Anchor w/Hex Nut, Zinc Plated CR+3	5/8" x 4 1/4"	10
278150	Sleeve Anchor w/Hex Nut, Zinc Plated CR+3	5/8" x 6"	10
278160	Sleeve Anchor w/Hex Nut, Zinc Plated CR+3	3/4" x 2 1/2"	10
278180	Sleeve Anchor w/Hex Nut, Zinc Plated CR+3	3/4" x 4 1/4"	5
278190	Sleeve Anchor w/Hex Nut, Zinc Plated CR+3	3/4" x 6 1/4"	5



- Superior U.S. Anchor quality
- Full lot traceability
- High quality packaging



The Ultimate Sleeve Anchor

HOLLOW BLOCK - Medium Duty Anchor For Installing Gates And Materials To Hollow Block - Zinc Plated

SLEEVE ANCHORS - FLAT HEAD



- Superior U.S. Anchor quality
- Full lot traceability
- High quality packaging

Part No.	Item Description	Size	Case Qty.
277003	Sleeve Anchor, Flat Head Phillips/Slotted Combo, Zinc Plated CR+3	1/4" x 1 1/8"	100
277005	Sleeve Anchor, Flat Head Phillips/Slotted Combo, Zinc Plated CR+3	1/4" x 1 3/8"	100
277020	Sleeve Anchor, Flat Head Phillips/Slotted Combo, Zinc Plated CR+3	1/4" x 2"	100
277040	Sleeve Anchor, Flat Head Phillips/Slotted Combo, Zinc Plated CR+3	1/4" x 3"	100
277060	Sleeve Anchor, Flat Head Phillips/Slotted Combo, Zinc Plated CR+3	1/4" x 4"	100
277070	Sleeve Anchor, Flat Head Phillips/Slotted Combo, Zinc Plated CR+3	3/8" x 2 3/4"	50
277080	Sleeve Anchor, Flat Head Phillips/Slotted Combo, Zinc Plated CR+3	3/8" x 4"	50
277090	Sleeve Anchor, Flat Head Phillips/Slotted Combo, Zinc Plated CR+3	3/8" x 5"	50
277100	Sleeve Anchor, Flat Head Phillips/Slotted Combo, Zinc Plated CR+3	3/8" x 6"	50
277110	Sleeve Anchor, Flat Head Phillips/Slotted Combo, Zinc Plated CR+3	3/8" x 3"	50
277120	Sleeve Anchor, Flat Head Phillips/Slotted Combo, Zinc Plated CR+3	5/16" x 2 1/2"	100
277130	Sleeve Anchor, Flat Head Phillips/Slotted Combo, Zinc Plated CR+3	5/16" x 3 1/2"	100



The Ultimate Sleeve Anchor

HOLLOW BLOCK - Medium Duty Anchor For Installing Gates And Materials To Hollow Block - Zinc Plated

SLEEVE ANCHORS - ROUND HEAD



- Superior U.S. Anchor quality

Part No.	Item Description	Size	Case Qty.
426005	Sleeve Anchor, Round Head Phillips/Slotted Combo, Zinc Plated CR+3	1/4" x 1 1/4"	100
426010	Sleeve Anchor, Round Head Phillips/Slotted Combo, Zinc Plated CR+3	1/4" x 2"	100
426022	Sleeve Anchor, Round Head Phillips/Slotted Combo, Zinc Plated CR+3	1/4" x 2 3/4"	100
426020	Sleeve Anchor, Round Head Phillips/Slotted Combo, Zinc Plated CR+3	3/8" x 2 1/2"	50
426030	Sleeve Anchor, Round Head Phillips/Slotted Combo, Zinc Plated CR+3	3/8" x 3 3/4"	50
426040	Sleeve Anchor, Round Head Phillips/Slotted Combo, Zinc Plated CR+3	3/8" x 4 3/4"	50



The Ultimate Sleeve Anchor

HOLLOW BLOCK - Medium Duty Anchor For Installing Gates And Materials To Hollow Block - Zinc Plated

SLEEVE ANCHORS - ACORN HEAD



- Superior U.S. Anchor quality

Part No.	Item Description	Size	Case Qty.
276020	Sleeve Anchor, Acorn Nut, Zinc Plated CR+3	1/4" x 1 3/8"	100
276030	Sleeve Anchor, Acorn Nut, Zinc Plated CR+3	1/4" x 2 1/4"	100



The Ultimate Sleeve Anchor

HOLLOW BLOCK - For Attaching Conduit And Strapping To Hollow Block - Zinc Plated

SLEEVE ANCHORS - ROD HANGER



Part No.	Item Description	Size	Case Qty.
R17001	Sleeve Type Rod Hangers, Zinc Plated CR+3	1/2" x 2 1/4"	25
R17002	Sleeve Type Rod Hangers, Zinc Plated CR+3	3/8" x 1 7/8"	50
R17003	Sleeve Type Rod Hangers, Zinc Plated CR+3	5/16" x 1 1/2"	50
R17004	Sleeve Type Rod Hangers, Zinc Plated CR+3	5/8" x 2 1/4"	20



The Ultimate Sleeve Anchor

HOLLOW BLOCK - Medium Duty Anchor For Hollow Block Providing Excellent Corrosion Resistance - Stainless 304

SLEEVE ANCHORS - HEX HEAD



Part No.	Item Description	Size	Case Qty.
618010	Stainless 304 Sleeve Anchor, Hex Head	1/4" x 1 3/8"	100
618020	Stainless 304 Sleeve Anchor, Hex Head	3/8" x 1 7/8"	50
618030	Stainless 304 Sleeve Anchor, Hex Head	3/8" x 3"	50
618040	Stainless 304 Sleeve Anchor, Hex Head	1/2" x 2 1/4"	25
618050	Stainless 304 Sleeve Anchor, Hex Head	1/2" x 4"	25
618060	Stainless 304 Sleeve Anchor, Hex Head	5/8" x 4 1/4"	10



**The Ultimate Drop-In Anchor
ASTM E488 TESTED**

CONCRETE - For Suspending Conduit, Fire Sprinklers And Lighting To Concrete - Zinc Plated

DROP-IN ANCHORS



Part No.	Item Description	Size	Case Qty.
268010	Drop-In Anchor w/Tool, Zinc Plated CR+3	1/4" W/Tool	100
268011	Drop-In Ancho, Zinc Plated CR+3	1/4"	50
268020	Drop-In Anchor w/Tool, Zinc Plated CR+3	3/8" W/Tool	100
268022	Drop-In Anchor, Zinc Plated CR+3	3/8"	20
268030	Drop-In Anchor w/Tool, Zinc Plated CR+3	1/2" W/Tool	50
268040	Drop-In Anchor w/Tool, Zinc Plated CR+3	5/8" W/Tool	25
268050	Drop-In Anchor w/Tool, Zinc Plated CR+3	3/4" W/Tool	25
268220	Drop-In Anchor, (3/8" Shorty w/Lip) and Tool, Zinc Plated CR+3	3/8" W/Tool	100



The Ultimate Drop-In Anchor

CONCRETE - For Suspending Conduit, Fire Sprinklers And Lighting To Concrete - Stainless 304

DROP-IN ANCHORS



Part No.	Item Description	Size	Case Qty.
619010	Stainless 304 Drop-In Anchors w/Tool	1/4"	100
619020	Stainless 304 Drop-In Anchors w/Tool	3/8"	100
619030	Stainless 304 Drop-In Anchors w/Tool	1/2"	50
619040	Stainless 304 Drop-In Anchors w/Tool	5/8"	25
619050	Stainless 304 Drop-In Anchors w/Tool	3/4"	25



**The Ultimate
Drywall Anchor**

USED IN DRYWALL - Light Duty Anchors For Installing Pictures, Mirrors, And Book Shelves Into Drywall - Zinc & Plastic

EZ-ANCHORS



Part No.	Item Description	Size	Case Qty.
R02001	E-Z Anchor Lite Duty White Nylon for use w/#6 Screws	3/8 x 1	100
R02005	E-Z Anchor Mini White Nylon for use w/#6, 7, & 8 Screws	1/2 x 1-5/8	100
R02007	E-Z Anchor Mini Zinc Die Cast for use w/#6, 7, & 8 Screws	7/16 x 1-1/4	100
R02008	E-Z Anchor Zinc Die Cast for use w/#6, 7, & 8 Screws	1/2 x 1-5/8	100
R02012	E-Z Anchor Toggle Zinc Die Cast for use w/#8 Screws	9/16 x 2-1/2	50
R02013	E-Z Anchor Toggle W/LG Wash Face Zinc Die Cast for use w/#8 Screws	9/16 x 2-1/2	50



**The Ultimate
Drywall Anchor**

USED IN DRYWALL - Light Duty Anchors For Plaster, Drywall, And Hollow Block - Zinc & Plastic

TOGGLER ANCHORS



- Easy slide adjustment, accomodates various wall thicknesses
- Can easily be removed and relocated

Part No.	Item Description	Size	Case Qty.
084001	Snap Toggler #24013 Anchor Zinc USA 3/8-3-5/8" Grip	100BA	100
084002	Snap Toggler #24014 Anchor Zinc USA 3/8-3-5/8" Grip	100BB	100
084003	Toggler #11009 Hollow Wall Anchor Nylon USA 1/8-1/4" Grip	100TA	100
084004	Toggler #11010 Hollow Wall Anchor Nylon USA 3/8-1/2" Grip	100TB	100
084005	Toggler #11011 Hollow Wall Anchor Nylon USA 5/8-3/4" Grip	100TC	100
084006	Toggler #11012 Picture Hook Anchor Nylon USA 3/8-1/2" Grip	100TH	100
084007	Snap Toggler #21015 Anchor Zinc USA 3/8-2-1/2" Grip	25BC	25
084008	Snap Toggler #24013 Anchor Zinc USA 3/8-3-5/8" Grip	50BA	50
143015	Toggle Bolts - Acoustical Zinc CR+3	1/4"-20 x 3'	25
143020	Toggle Bolts - Acoustical Zinc CR+3	1/4"-20 x 4"	25
143025	Toggle Bolts - Acoustical Zinc CR+3	1/4"-20 x 5"	25







Ironclad®

**HIGH-PERFORMANCE
WORK GLOVES FOR
CONSTRUCTION PROFESSIONALS**





TASK SPECIFIC HAND PROTECTION



WELCOME TO IRONCLAD

Ironclad was founded on a construction site in 1998 by Ed Jaeger. Ed noticed that while every specialist utilized dedicated, task specific tools, no one had addressed the special connection between tool and worker. With an extensive background in motorsports, Ed came from a world where glove performance, fit, and comfort were vital. It was at that moment that Ed saw his mission - to create gloves that were both protective and driven by performance, without sacrificing either. Thus was born a new glove technology that incorporated military grade fabrics, with an unrivaled fit and comfort, that would raise the industry to new standards.

WHAT SETS IRONCLAD APART

TESTING

Being on the cutting edge of glove innovation means venturing into uncharted territories. When it comes to evaluating performance, we go above and beyond traditional testing - we partner with scientists, leaders and experts in fields ranging from biomechanics to high tech outdoor gear, and create new ways to analyze, evaluate and test performance features of our work gloves.

At Ironclad, we understand that every job is different, every worksite is unique, and every hand is one-of-a-kind. We learn more by being in the field, with you, than we could ever know sitting in an office. That's why we spend so much time at jobsites, with front line workers, watching, learning, testing our ideas, and listening to your feedback. This is how every one of our glove designs gets created. So we encourage you to field test with us. Chances are we have just the right glove for you. And if we don't, we will build it.

FLAWLESS FIT SYSTEM

When it comes to fit, most glove companies stop at 2 measurements per glove - overall length and width. Not Ironclad. Our industry leading Flawless Fit is a proprietary 16-point measurement system that is unique to every one of our glove styles. So what do we measure? Inside

index finger length, top of cuff circumference, knuckle circumference, center of palm length, just for starters. 16 measurements left glove, 16 measurements right glove. That's 32 measurements per pair, per size. All with a tolerance measured at 1/10 of an inch. Why do we do it? Because it means our gloves will fit like no other glove on the market. That is the Ironclad Flawless Fit. That is Ironclad.

EXPANDING BEYOND GLOVES INTO NEW PPE

Ironclad has always focused on providing superior protection to the industrial athlete - through innovation, quality, comfort and durability. And now, it's exciting to expand beyond hand protection, and to bring Ironclad level quality, comfort and durability to head protection made right here in America."

Both the Yukon™ and Rainier™ Series are proudly Made in the USA to the highest engineering standards in the head protection industry. Designed for premium comfort, fit and protection, everything you have come to expect from Ironclad safety gear.

Learn more about Ironclad, and find the right glove for your next job at www.ironclad.com



HAND PROTECTION - Touchscreen Redefined Forever

CUT RESISTANT



G03039



G03047



G03234



G03254



G03274



G03294



G03394



M09030

Part No.	Item Description	Size	Pkg. Qty.
G03036	Command Knit Foam Nitrile - Touch Screen, Cut Level A1, (Vend-Pack)	XS	12
G03037	Command Knit Foam Nitrile - Touch Screen, Cut Level A1, (Vend-Pack)	S	12
G03038	Command Knit Foam Nitrile - Touch Screen, Cut Level A1, (Vend-Pack)	M	12
G03039	Command Knit Foam Nitrile - Touch Screen, Cut Level A1, (Vend-Pack)	L	12
G03040	Command Knit Foam Nitrile - Touch Screen, Cut Level A1, (Vend-Pack)	XL	12
G03041	Command Knit Foam Nitrile - Touch Screen, Cut Level A1, (Vend-Pack)	XXL	12
G03044	Command Knit PU - Touch Screen, Cut Level A1, (Vend-Pack)	XS	12
G03045	Command Knit PU - Touch Screen, Cut Level A1, (Vend-Pack)	S	12
G03046	Command Knit PU - Touch Screen, Cut Level A1, (Vend-Pack)	M	12
G03047	Command Knit PU - Touch Screen, Cut Level A1, (Vend-Pack)	L	12
G03048	Command Knit PU - Touch Screen, Cut Level A1, (Vend-Pack)	XL	12
G03049	Command Knit PU - Touch Screen, Cut Level A1, (Vend-Pack)	XXL	12
G03231	Command A2 PU - Touch Screen, Cut Level A2, (Vend-Pack)	XS	12
G03232	Command A2 PU - Touch Screen, Cut Level A2, (Vend-Pack)	S	12
G03233	Command A2 PU - Touch Screen, Cut Level A2, (Vend-Pack)	M	12
G03234	Command A2 PU - Touch Screen, Cut Level A2, (Vend-Pack)	L	12
G03235	Command A2 PU - Touch Screen, Cut Level A2, (Vend-Pack)	XL	12
G03236	Command A2 PU - Touch Screen, Cut Level A2, (Vend-Pack)	XXL	12
G03251	Command A3 Foam Nitrile - Touch Screen, Cut Level A3, (Vend-Pack)	XS	12
G03252	Command A3 Foam Nitrile - Touch Screen, Cut Level A3, (Vend-Pack)	S	12
G03253	Command A3 Foam Nitrile - Touch Screen, Cut Level A3, (Vend-Pack)	M	12
G03254	Command A3 Foam Nitrile - Touch Screen, Cut Level A3, (Vend-Pack)	L	12
G03255	Command A3 Foam Nitrile - Touch Screen, Cut Level A3, (Vend-Pack)	XL	12
G03256	Command A3 Foam Nitrile - Touch Screen, Cut Level A3, (Vend-Pack)	XXL	12
G03271	Command A4 Foam Nitrile - Touch Screen, Cut Level A4, (Vend-Pack)	XS	12
G03272	Command A4 Foam Nitrile - Touch Screen, Cut Level A4, (Vend-Pack)	S	12
G03273	Command A4 Foam Nitrile - Touch Screen, Cut Level A4, (Vend-Pack)	M	12
G03274	Command A4 Foam Nitrile - Touch Screen, Cut Level A4, (Vend-Pack)	L	12
G03275	Command A4 Foam Nitrile - Touch Screen, Cut Level A4, (Vend-Pack)	XL	12
G03276	Command A4 Foam Nitrile - Touch Screen, Cut Level A4, (Vend-Pack)	XXL	12
G03291	Command A6 Foam Nitrile - Touch Screen, Cut Level A6, (Vend-Pack)	XS	12
G03292	Command A6 Foam Nitrile - Touch Screen, Cut Level A6, (Vend-Pack)	S	12
G03293	Command A6 Foam Nitrile - Touch Screen, Cut Level A6, (Vend-Pack)	M	12
G03294	Command A6 Foam Nitrile - Touch Screen, Cut Level A6, (Vend-Pack)	L	12
G03295	Command A6 Foam Nitrile - Touch Screen, Cut Level A6, (Vend-Pack)	XL	12
G03296	Command A6 Foam Nitrile - Touch Screen, Cut Level A6, (Vend-Pack)	XXL	12
G03391	Command Microfoam Nitrile - Touch Screen, (Vend-Pack)	XS	12
G03392	Command Microfoam Nitrile - Touch Screen, (Vend-Pack)	S	12
G03393	Command Microfoam Nitrile - Touch Screen, (Vend-Pack)	M	12
G03394	Command Microfoam Nitrile - Touch Screen, (Vend-Pack)	L	12
G03395	Command Microfoam Nitrile - Touch Screen, (Vend-Pack)	XL	12
G03996	Command Microfoam Nitrile - Touch Screen, (Vend-Pack)	XXL	12
G03997	Command Microfoam Nitrile - Touch Screen, (Vend-Pack)	XXXL	12
M09030	Foam Standing/Kneeling Pad	21" x 14" x 1"	1

• Command touchscreen infused palm • 18 gauge premium shell • Color coded reinforced saddle



G03414

G03412	Crinkle Latex A1, (Vend-Pack)	S	12
G03413	Crinkle Latex A1, (Vend-Pack)	M	12
G03414	Crinkle Latex A1, (Vend-Pack)	L	12
G03415	Crinkle Latex A1, (Vend-Pack)	XL	12
G03416	Crinkle Latex A1, (Vend-Pack)	XXL	12
G03417	Crinkle Latex A1, (Vend-Pack)	XXXL	12



**Head Protection
to Keep Safety
Top of Mind**

HEAD PROTECTION

Part No.	Item Description	Color	Case Qty.
----------	------------------	-------	-----------



G60002

YUKON™ CS400: 4 - Point suspension system offers superior protection for top impact with good side protection. Ratchet adjusts between hat sizes 6-1/2" to 8". Universal accessory slot. Compatible with 2 or 3 chin straps. Vertical height adjustment capability (2 front, 2 rear) allows for a more personal fit to increase wear time and worker compliance. Meets ANSI/ISEA Z89.1 standards.

G60000	Yukon CS400 - Standard Brim, Vented, 4 Point, Type 1, Class C	White	20
G60001	Yukon CS400 - Standard Brim, Vented, 4 Point, Type 1, Class C	Blue	20
G60002	Yukon CS400 - Standard Brim, Vented, 4 Point, Type 1, Class C	Yellow	20
G60004	Yukon CS400 - Standard Brim, Vented, 4 Point, Type 1, Class C	Orange	20



G60106

YUKON™ ES400: 4 - Point suspension system offers superior protection for top impact with good side protection. Ratchet adjusts between hat sizes 6-1/2" to 8". Universal accessory slot. Compatible with 2 or 3 chin straps. Vertical height adjustment capability (2 front, 2 rear) allows for a more personal fit to increase wear time and worker compliance. Meets ANSI/ISEA Z89.1 and CSA Z94.1 standards.

G60104	Yukon ES400 - Standard Brim, Non Vented, 4 Point, Type 1, Class E	White	20
G60105	Yukon ES400 - Standard Brim, Non Vented, 4 Point, Type 1, Class E	Blue	20
G60106	Yukon ES400 - Standard Brim, Non Vented, 4 Point, Type 1, Class E	Yellow	20
G60107	Yukon ES400 - Standard Brim, Non Vented, 4 Point, Type 1, Class E	Orange	20



G60102

YUKON™ ES600: 6 - Point suspension system offers superior protection for front, top, lateral and off axis impacts. Ratchet adjusts between hat sizes 6-1/2" to 8". Universal accessory slot. Compatible with 2 or 3 chin straps. Vertical height adjustment capability (2 front, 2 rear) allows for a more personal fit to increase wear time and worker compliance. Meets ANSI/ISEA Z89.1 and CSA Z94.1 standards.

G60100	Yukon ES600 - Standard Brim, Non Vented, 6 Point, Type 1, Class E	White	20
G60101	Yukon ES600 - Standard Brim, Non Vented, 6 Point, Type 1, Class E	Blue	20
G60102	Yukon ES600 - Standard Brim, Non Vented, 6 Point, Type 1, Class E	Yellow	20
G60103	Yukon ES600 - Standard Brim, Non Vented, 6 Point, Type 1, Class E	Orange	20



G60201

YUKON™ EF400: 4 - Point suspension system offers superior protection for top impact with good side protection. Ratchet adjusts between hat sizes 6-1/2" to 8". Universal accessory slot. Compatible with 2 or 3 chin straps. Vertical height adjustment capability (2 front, 2 rear) allows for a more personal fit to increase wear time and worker compliance. Meets ANSI/ISEA Z89.1 and CSA Z94.1 standards.

G60200	Yukon EF400 - Full Brim, Non Vented, 4 Point, Type 1, Class E	White	10
G60201	Yukon EF400 - Full Brim, Non Vented, 4 Point, Type 1, Class E	Yellow	10



G62002

RAINIER™ BC40: Short bill offers protection from bump hazards in tight spaces. Slide lock 4 - point suspension system for lightweight comfort. Vented design allows for added air circulation. Polyester brow pad. Compatible with 2 point chin straps.

G62001	Rainier BC40 - Short Brim Hard Bump Cap	White	25
G62002	Rainier BC40 - Short Brim Hard Bump Cap	Yellow	25
G62003	Rainier BC40 - Short Brim Hard Bump Cap	Blue	25



G62004

RAINIER™ BCX: Ball cap style brim. Low-profile head protection. Snap back adjustable closure fits a wide range of head sizes. Ventilated removable bump insert with crown pad. Breathable construction.

G62004	Rainier BCX - Snap Back Bump Cap	Black	36
--------	----------------------------------	-------	----

ADDITIONAL CONSTRUCTION PRODUCTS

BOLT & SCREW PRODUCTS

Family #	Product Description
493	Hex Bolts, Plain
494	Hex Bolts, Zinc Plated
495	Hex Bolts, HDG
400	Hex Cap Screws, 18,8 Stainless
401	Hex Cap Screws, 316 Stainless
488	Carriage Bolts, Plain
489	Carriage Bolts, Zinc Plated
490	Carriage Bolts, HDG
781	Carriage Bolts, 18,8 Stainless
W69	Carriage Bolts, 316 Stainless
485	Hex Lag Screws, Plain
486	Hex Lag Screws, Zinc Plated
487	Hex Lag Screws, HDG
782	Hex Lag Screws, 18,8 Stainless
W70	Hex Lag Screws, 316 Stainless
508	A325 TC Bolt, Plain, Import
438	A325 TC Bolt, Plain, USA
497	A325 Type 1, HDG, Import
480	A325 Type 1, HDG, USA
496	A325 Type 1, Plain, Import
503	A325 Type 1, Plain USA

NUT PRODUCTS

Family #	Product Description
317	Finished Hex Nuts, Plain
319	Finished Hex Nuts, Zinc Plated
323	Finished Hex Nuts, HDG
762	Finished Hex Nuts, 18-8 Stainless
763	Finished Hex Nuts, 316 Stainless
334	563 Grade C Heavy Hex Nuts, Plain
324	A563 A Heavy Hex Nuts, HDG
895	Hex Coupling Nuts, Plain
303	Hex Coupling Nuts, Zinc Plated
896	Hex Coupling Nuts, HDG
048	Hex Coupling Nuts, 18-8 Stainless
056	Hex Coupling Nuts, 316 Stainless

THREADED ROD PRODUCTS

Family #	Product Description
776	A307 Threaded Rod, Plain
777	A307 Threaded Rod, Plated
770	A307 Threaded Rod, HDG
778	A193 (B7) Threaded Rod, Plain
886	Threaded Rod, 18-8 Stainless
887	Threaded Rod 316 Stainless

Lengths ranging from 1', 2', 3', 6', 10', 12'

In-house rod cutting service done to your specific length. Threaded Rod must be purchased through BBI.

WASHER PRODUCTS

Family #	Product Description
394	Flat Washers, 18-8 Stainless
398	Flat Washers, 316 Stainless
343	USS Flat Washers, Plain
344	USS Flat Washers, Zinc Plated
345	USS Flat Washers, HDG
347	SAE Flat Washers, Zinc Plated
296	Square Plate Washers, Plain
297	Square Plate Washers, HDG
021	Round Plate Washers, Plain
022	Round Plate Washers, HDG
P38	Round Malleable Washers, HDG
P39	Round Malleable Washers, Plain

HAND TOOLS & CUTTING TOOLS

Family #	Product Description
C20	Metal Cutting Drill Bits
C50	Wood Cutting Drill Bits

Proffered® Hand Tools ranging from Master Socket Sets, Socket Sets, Sockets, Adjustable Wrenches, Ratcheting Wrenches, Screwdrivers, Pliers, and more.



Proffered® vending and lockers. Manage your customer's safety products and consumables right from your computer!

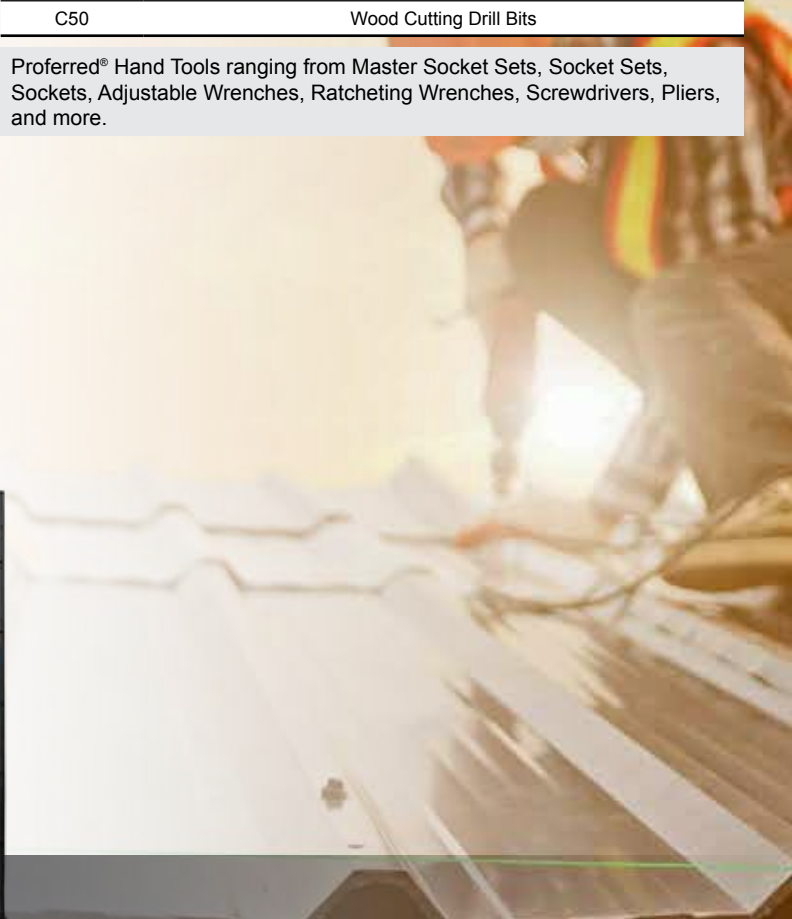



Proffered®

Global Headquarters

Tainan, Taiwan
No.122, Yi-Lin Road,
Rende Township,
Tainan, 71752 Taiwan
Tel. 886-6-270-1756

USA Headquarters

Long Beach, California
5855 Obispo Ave.
Long Beach, CA 90805
Tel. 562-808-8000
Fax: 562-808-8137

U.S.A.

Atlanta, GA
250 Horizon Dr.
Suwanee, GA 30024
Tel. 678-459-3700
Fax: 678-459-3720
WATS: 800-275-0056
atlanta@brightonbest.com

Boston, MA
448 Turnpike St.
South Easton, MA 02375
Tel. 508-857-2808
Fax: 774-296-8685
WATS: 800-275-0037
boston@brightonbest.com

Charlotte, NC
8604 Cliff Cameron Dr., Ste. 154
Charlotte, NC 28269
Tel. 704-393-6711
Fax: 704-393-6715
WATS: 800-275-0050
charlotte@brightonbest.com

Chicago, IL
940 North Enterprise St.
Aurora, IL 60504
Tel. 630-898-9600
Fax: 630-898-9601
WATS: 800-929-2378
chicago@brightonbest.com

Cleveland, OH
21855 Commerce Pkwy,
Strongsville, OH 44149
Tel. 440-238-1350
Fax: 440-238-2336
WATS: 800-275-0048
cleveland@brightonbest.com

Dallas, TX
3225 Roy Orr Blvd., Ste. 200
Grand Prairie, TX 75050
Tel. 972-790-1201
Fax: 972-790-6265
WATS: 800-275-0054
dallas@brightonbest.com

Denver, CO
9700 E. 56th Ave., Unit 120
Denver, CO 80238
Tel. 303-576-0530
Fax: 303-371-9775
WATS: 800-935-2202
denver@brightonbest.com

Detroit, MI
6060 Stoney View Drive, Ste. 100
Shelby Township, MI 48316
Tel. 586-412-3350
Fax: 586-412-3305
WATS: 800-275-0046
detroit@brightonbest.com

Houston, TX

6911 Fairbanks N. Houston Rd. Ste. 150
Houston, TX 77040
Tel: 713-466-0336
Fax: 713-466-0385
WATS: 800-275-0054
houston@brightonbest.com

Los Angeles, CA

12801 Leffingwell Ave.
Santa Fe Springs, CA 90670
Tel. 562-483-2740
Fax: 562-404-3999
WATS: 800-275-0028
losangeles@brightonbest.com

Miami, FL

3426 West 84th St., Ste. 203
Hialeah, FL 33018
Tel. 305-512-3446
Fax: 305-512-3450
WATS: 800-275-0035
miami@brightonbest.com

Nashville, TN

446 Metroplex Dr., Ste. A120
Nashville, TN 37211
Tel. 615-834-1154
Fax: 615-834-1157
WATS: 800-275-0029
nashville@brightonbest.com

Portland, OR

4820 NE 138th Ave.
Portland, OR 97230
Tel: 503-261-0660
Fax: 503-252-4093
WATS: 800-275-0686
portland@brightonbest.com

Minneapolis, MN

21010 Commerce Blvd.
Ste. B
Rogers, MN 55374
Tel. 763-425-9464
Fax: 763-425-9266
WATS: 800-275-0031
minnesota@brightonbest.com

Salt Lake City, UT

2179 S. Commerce Center Dr. Ste. 400
West Valley City, UT 84120
Tel: 801-972-1313
Fax: 801-972-5114
WATS: 800-935-1402
saltlake@brightonbest.com

Sayreville, NJ

200 Kennedy Dr.
Sayreville, NJ. 08872
Tel. 732-525-8400
Fax: 732-525-8408
sayreville@brightonbest.com

Seattle, WA

20308 59th Place South, Bldg. 1A
Kent, WA, 98032
Tel. 253-872-3417
Fax: 253-872-3415
WATS: 800-935-1502
seattle@brightonbest.com

St. Louis, MO

1856 Craig Rd.
St. Louis, MO 63146
Tel. 314-205-8001
Fax: 314-205-0857
WATS: 800-275-0047
stlouis@brightonbest.com

Tampa, FL

4915 Distribution Dr.
Tampa, FL 33605
Tel. 305-512-3446
Fax: 305-512-3450
WATS: 800-275-0035
tampa@brightonbest.com

West Deptford, NJ

1222 Forest Parkway
West Deptford, NJ. 08066
Tel. 856-241-9494
Fax: 856-241-9477
WATS: 800-935-2378
sayreville@brightonbest.com

IRONCLAD HQ

Dallas, TX
3325 Roy Orr Blvd., Ste. 200
Grand Prairie, TX. 75050
Tel. 972-996-5664
Fax: 469-341-7213
Toll Free: 844-200-5664
customerservice@ironclad.com

CANADA

Montreal, Québec

12000 Cavendish
Saint-Laurent, Québec H4R 1Y2
Tel: 514-336-9888
Fax: 514-336-8865
WATS: 800-361-2076
montreal@brightonbest.com

Toronto, Ontario

7900 Goreway Dr., Unit 1
Brampton, Ontario L6T 5W6
Tel: 905-791-2000
Fax: 905-791-6841
WATS: 800-268-6918
toronto@brightonbest.com

Vancouver, British Columbia

9489 200 St, Unit 103&104
Langley, B.C. V1M 3A7
Tel: 604-513-0311
Fax: 604-513-0312
WATS: 800-663-9106
vancouver@brightonbest.com

MEXICO

Mexico
Toll Free: 1(855)-816-9726
Fax: 562-404-3999
mexico@brightonbest.com

AUSTRALIA

Brisbane, Queensland
11 Stradbroke St.
Heathwood, Queensland 4110
Tel. 617-3727-5700
Fax: 617-3714-9821
qldsales@brightonbest.com.au

Melbourne, Victoria

31-33 Canterbury Rd.
Brassie, VIC 3195
Tel. 613-8586-0244
Fax: 613-9587-7255
vicsales@brightonbest.com.au

Perth, Western Australia

Unit 3/420 Victoria Rd.
Malaga, Western Australia 6090
Tel. 618-6240-6800
Fax: 618-9248-4766
wasales@brightonbest.com.au

Sydney, New South Wales

1 Wonderland Dr.,
Eastern Creek, NSW 2766
Tel. 612-8818-0900
Fax: 612-9620-1050
nswsales@brightonbest.com.au

NEW ZEALAND

Auckland, New Zealand

28B Pavillion Dr. Airport Oaks
Mangere, Auckland 2022
Tel. 649-257-5256
Fax: 649-257-5328
nzsales@brightonbest.co.nz

U.K.

Birmingham, West Midlands

Fastener Complex D1
Cradley Business Park,
Overend Rd., Cradley Heath
West Midlands B64 7DW
Tel. +44 (0) 1384-568144
Fax: +44 (0) 1384-413719
sales@brightonbest.org

BRAZIL

São Paulo, Brazil

Rua Dos Missionários, 410
São Paulo, Brazil 04729-001
Tel. 55 11-5641-4037
Fax: 55 11-5641-2444
luizab@brightonbest.com.br

